

STAUFF TEST has established a reputation for a comprehensive range of test points and accessories for hydraulic and pneumatic systems for many years now.

STAUFF TEST stands for a varied spectrum of screw-in test points and test couplings for tube fittings, which are oriented to international standards and therefore guaranteed to comply with the requirements of applications all over the world.

The extensive range of accessories, including measuring hoses and pressure gauges (mechanical and digital/electronic) means that the initial test points fitted onto machines and service kits with measuring instruments can be obtained from a single source.

All products are subject to our in-house quality management in accordance with EN ISO 9001:2008. This ensures a consistently high standard of quality.

Our company has also been certified in the fields of environmental protection acc. to DIN EN ISO 14001:2004 and occupational safety acc. to OHSAS 18001:2007.

Our well-stocked warehouse and flexible production line ensure prompt reactions and short delivery times. Furthermore, special versions that have been tailored to customer-specific requirements are available to order.

The following approvals are also available for special versions of the SKK test points:

- approved for military use as gas filling valve for nitrogen accumulators by the German Bundeswehr "Wehrtechnische Dienststelle für Pionier- und Truppengerät".
- DVGW registration as a test point for gas pressure control systems, issued by the German Association of Gas and Water Industries (DVGW).

Please contact STAUFF for further details.

www.stauff.com

B STAUFF Test

Index	B2
Test 20 - Connection Thread M16 x 2	B4
Test 15 - Connection Thread M16 x 1,5	B16
Test 12 - Connection Thread S12,65 x 1,5	B22
Test 10 - Plug in system	B28
Adaptors	B32
Pressure Gauge Accessories	B34
Test Hoses / Hose Ends	B36
Technical Appendix	B46

Test 20 - Connection Thread M16 x 2 - SMK20

	Introduction - Test Coupling with Ball Check		B4
	Test Coupling with Port Connection	SMK20	B5
	Test Coupling complete with Straight Fitting	SMK20 Type G	B6
	Test Coupling for 24° Cone Fittings	SMK20 Type K	B7
	Test Coupling SMK-JIC Connection	SMK20-JIC Type K	B8
	Test Coupling SMK-JIC Connection	SMK20-JIC Type G	B8
	Swivel Run Tee with JIC Connection	SGV-JIC Type F/M	B9
	Test Coupling with ORFS Connection	SMK20 Type ORFS	B9
	Bulkhead	SSK20	B10
	Adaptor	SAD20	B11
	Gauge Adaptor Direct Gauge Adaptor	SMA20 SMD20	B11

Test 20 - Connection Thread M16 x 2 - SKK20

	Introduction - Test Coupling with Piston Valve		B12
	Test Coupling with Port Connection	SKK20	B13
	Test Coupling complete with Straight Fitting	SKK20 Type G	B14
	Test Coupling for 24° Cone Fittings	SKK20 Type K	B15











Test 15 - Connection Thread M16 x 1,5 - SMK15

	Introduction - Test Coupling with Ball Check		B16
	Test Coupling with Port Connection	SMK15	B17
	Test Coupling complete with Straight Fitting	SMK15 Type G	B18
	Test Coupling for 24° Cone Fittings	SMK15 Type K	B19
	Bulkhead	SSK15	B20
	Swivel Run Tee with JIC Connection	SGV-JIC Type F/M	B20
	Adaptor	SAD15	B21
	Gauge Adaptor Direct Gauge Adaptor	SMA15 SMD15	B21





Test 12 - Connection Thread S12,65 x 1,5 - SKK12

	Introduction - Test Coupling with Piston Valve		B22
	Test Coupling with Port Connection	SKK12	B23
	Test Coupling complete with Straight Fitting	SKK12 Type G	B24
	Test Coupling for 24° Cone Fittings	SKK12 Type K	B25
	Bulkhead	SSK12	B26
	Swivel Run Tee with JIC Connection	SGV-JIC Type F/M	B26
	Adaptor	SAD12	B27
	Gauge Adaptor Direct Gauge Adaptor	SMA12 SMD12	B27



Test 10 - Plug In System - SMK10
Test Hoses

	Introduction - Test Coupling with Ball Check		B28		Technical Data for Test Hose	SMS / SGS	B36
	Test Coupling with Port Connection	SMK10	B29		Order Codes Test Hose / Hose End	SMS / SGS and HE	B37
	Gauge Adaptor	SMA10	B29		Hose End	HE	B38
	Test Coupling complete with Straight Fitting	SMK10 Type G	B30		Hose Connector	SSV	B44
	Test Coupling for 24° Cone Fittings	SMK10 Type K	B31		Sampling Hose Adaptor	SHA	B44

Adaptors
Technical Appendix

	Thread Adaptor	SRS20	B32		Port Connections and Sealing Details		B46
	Thread Adaptor	SRS15	B33				
	Welding Adaptor	SAS	B33				

Pressure Gauge Accessories

	Pressure Gauge	SPG	B34				
	Adjustable Gauge Fitting	EMV	B34				
	Pressure Test Kit	SMB	B35				

Test Coupling with Ball Check

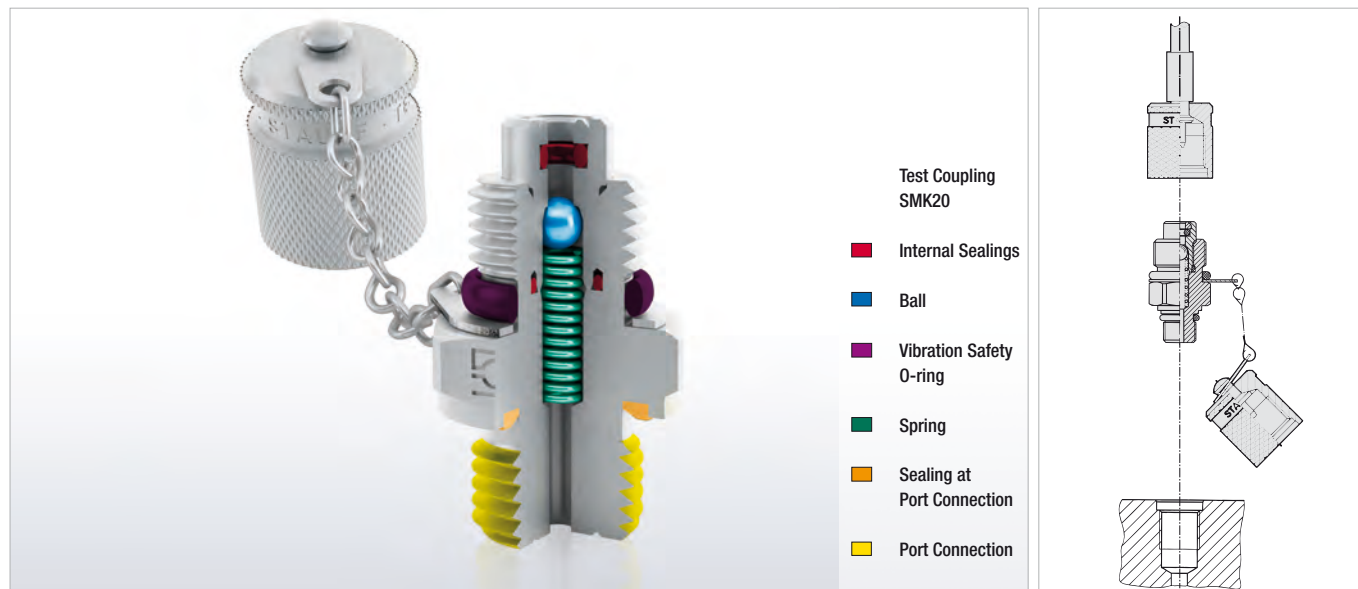

Fast Coupling for

- Monitoring and control of pressure
- Venting
- Sampling in high- and low-pressure systems

Advantages

- Test system at working pressure
- Leak proof connection before **ball check** is open
- Simple connection to measurement, control and switching devices
- Self locking metal protective cap

Working Pressure

- Max. working pressure 630 bar / 9137 PSI
For SMK Type G and K the recommended working pressure of fitting manufacturer should be noted.
- Connection under pressure up to 400 bar / 5801 PSI max.

Materials

- Metal Parts:**
Standard material: Steel, zinc/nickel-plated = **C6F (CrVI-free)**
Optional:
Stainless Steel **V2A** (1.4305 / AISI 303) on request
Stainless Steel **V4A** (1.4571 / AISI 316Ti) on request

For ordering "V2A" or "V4A" please replace "C6F" with "V2A" or "V4A".

- Ball:** Stainless Steel

Sealings:

P = NBR (Buna-N®)

(Temperature range -20 °C ... +100 °C / -4 °F ... +212 °F)

Note: Internal sealings made of FPM, even for standard NBR-type.

V = FPM (Viton®)*

(Temperature range -20 °C ... +200 °C / -4 °F ... +392 °F)

*** Standard option for North America is FPM (Viton®)**

E = EPDM Ethylene Propylene Diene Monomer Rubber

(for Brake fluid,

Temperature range -40 °C ... +150 °C / -40 °F ... +302 °F)

For ordering FPM or EPDM sealings please replace "P" with "V" or "E".

Vibration safety O-ring made of NBR (Buna-N®) (standard).

Media

- Suitable for hydraulic oils and other Mineral oil based fluids
(Check compatibility of sealing material)
- For use with other liquid media please consult STAUFF

Protection Cap

- The complete STAUFF-Test-20-type-SMK range is also available with a hexagonal protection cap made of steel or plastic protection cap.

For ordering the hexagonal protection cap version please add "-SK" to the order code.

(e.g. SMK20-M10x1-PA-SK-C6F)

For ordering the plastic protection cap version please add "-KK" to the order code.

(e.g. SMK20-M10x1-PA-KK-C6F)

SMK20 Test Coupling with Port Connection	SMK20 Type G Test Coupling complete with Straight Fitting	SMK20 Type K Test Coupling for 24° Cone Fittings	SMK20-JIC Test Coupling SMK-JIC Connection (to SAE J514)	SSK20 Bulkhead

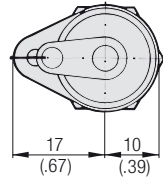
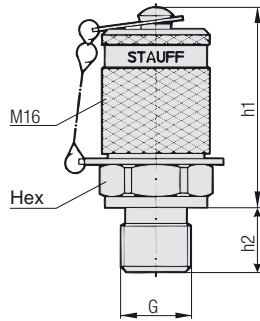

Test Coupling with Port Connection SMK20



Thread G	Sealing	Working Pressure (bar/psi)	Dimensions (mm/in)			Order Codes	
			h1	h2	Hex	NBR	FPM* (Standard Option-North America)
M8 x 1	Type A	250	38	8,5	17	SMK20-M8x1-PA-C6F	SMK20-M8x1-VA-C6F
		3625	1.50	.33	.67		
M10 x 1	Type A	630	38	9,8	17	SMK20-M10x1-PA-C6F	SMK20-M10x1-VA-C6F
		9137	1.50	.39	.67		
M10 x 1	Type B	400	37	8	17	SMK20-M10x1-PB-C6F	SMK20-M10x1-VB-C6F
M12 x 1,5		5801	1.46	.31	.67		
M12 x 1,5	Type B	630	37	12	17	SMK20-M12x1,5-PB-C6F	SMK20-M12x1,5-VB-C6F
		9137	1.46	.47	.67		
M14 x 1,5	Type B	630	37	12	19	SMK20-M14x1,5-PB-C6F	SMK20-M14x1,5-VB-C6F
		9137	1.46	.47	.75		
M16 x 1,5	Type B	630	37	12	22	SMK20-M16x1,5-PB-C6F	SMK20-M16x1,5-VB-C6F
		9137	1.46	.47	.87		
G1/8	Type C	400	39	8	17	SMK20-G1/8-PB-C6F	SMK20-G1/8-VB-C6F
		5801	1.54	.31	.67		
G1/4	Type C	630	37	12	19	SMK20-G1/4-PB-C6F	SMK20-G1/4-VB-C6F
		9137	1.46	.47	.75		
G3/8	Type C	630	37	12	22	SMK20-G3/8-PB-C6F	SMK20-G3/8-VB-C6F
		9137	1.46	.47	.87		
M10 x 1	Type C	400	39	8	17	SMK20-M10x1-PC-C6F	SMK20-M10x1-VC-C6F
		5801	1.54	.31	.67		
M12 x 1,5	Type C	630	37	12	17	SMK20-M12x1,5-PC-C6F	SMK20-M12x1,5-VC-C6F
		9137	1.46	.47	.67		
M14 x 1,5	Type C	630	37	12	19	SMK20-M14x1,5-PC-C6F	SMK20-M14x1,5-VC-C6F
		9137	1.46	.47	.75		
M16 x 1,5	Type C	630	37	12	22	SMK20-M16x1,5-PC-C6F	SMK20-M16x1,5-VC-C6F
		9137	1.46	.47	.87		
G1/8	Type C	400	39	8	17	SMK20-G1/8-PC-C6F	SMK20-G1/8-VC-C6F
		5801	1.54	.31	.67		
G1/4	Type C	630	37	12	19	SMK20-G1/4-PC-C6F	SMK20-G1/4-VC-C6F
		9137	1.46	.47	.75		
G3/8	Type C	630	37	12	22	SMK20-G3/8-PC-C6F	SMK20-G3/8-VC-C6F
		9137	1.46	.47	.87		
G1/2	Type C	630	39	14	27	SMK20-G1/2-PC-C6F	SMK20-G1/2-VC-C6F
		9137	1.54	.55	1.06		
R1/8 K	Type D	400	37	8	17	SMK20-R1/8K-PD-C6F	SMK20-R1/8K-VD-C6F
		5801	1.46	.31	.67		
R1/4 K	Type D	630	35	12	17	SMK20-R1/4K-PD-C6F	SMK20-R1/4K-VD-C6F
		9137	1.38	.47	.67		
1/8 NPT	Type D	400	36	10	17	SMK20-1/8NPT-PD-C6F	SMK20-1/8NPT-VD-C6F
		5801	1.42	.39	.67		
1/4 NPT	Type D	630	35	15	17	SMK20-1/4NPT-PD-C6F	SMK20-1/4NPT-VD-C6F
		9137	1.38	.59	.67		
5/16-24 UNF	Type E	400	38	7,5	17	SMK20-5/16UNF-PE-C6F	SMK20-5/16UNF-VE-C6F
		5.801	1.50	.30	.67		
7/16-20 UNF	Type E	630	38	9,1	17	SMK20-7/16UNF-PE-C6F	SMK20-7/16UNF-VE-C6F
		9137	1.50	.36	.67		
1/2-20 UNF	Type E	630	38	9,2	17	SMK20-1/2UNF-PE-C6F	SMK20-1/2UNF-VE-C6F
		9137	1.50	.36	.67		
9/16-18 UNF	Type E	630	37	10	19	SMK20-9/16UNF-PE-C6F	SMK20-9/16UNF-VE-C6F
		9137	1.46	.39	.75		
3/4-16 UNF	Type E	630	37	11,1	19	SMK20-3/4UNF-PE-C6F	SMK20-3/4UNF-VE-C6F
		9137	1.46	.44	.75		
M10 x 1	Type E	630	38	9,5	17	SMK20-M10x1-PE-C6F	SMK20-M10x1-VE-C6F
		9137	1.50	.37	.67		
M12 x 1,5	Type E	630	37	11	17	SMK20-M12x1,5-PE-C6F	SMK20-M12x1,5-VE-C6F
		9137	1.46	.43	.67		
M14 x 1,5	Type E	630	38	11	19	SMK20-M14x1,5-PE-C6F	SMK20-M14x1,5-VE-C6F
		9137	1.50	.43	.75		

Metal Parts

Standard material: Steel, zinc/nickel-plated = **C6F (CrVI-free)**
 For ordering V2A (1.4305 / AISI 303) replace "C6F" with "V2A".
 For ordering V4A (1.4571 / AISI 316Ti) replace "C6F" with "V4A".

Sealings

For ordering FPM sealings replace "P" with "V".
 For ordering EPDM sealings replace "P" with "E".

* Standard option for North America is FPM (Viton®).

Sealing Details

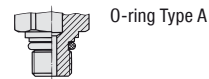

O-ring Type A



Metal Joint Type B



Elastomeric Sealing Type C



Taper Type D
(suitable sealant required)



O-ring Type E

Protection Cap

Standard material: Steel
 For ordering the hexagonal protection cap version please add "-SK" to the order code. (e.g. SMK20-M10x1-PA-SK-C6F)
 For ordering the plastic protection cap version please add "-KK" to the order code. (e.g. SMK20-M10x1-PA-KK-C6F)

For further information on materials, sealings or protection caps, please see page B4.

Other port connections and sealings on request.
 Please consult STAUFF for further information.

**Test Coupling complete with Straight Fitting
SMK20 Type G**

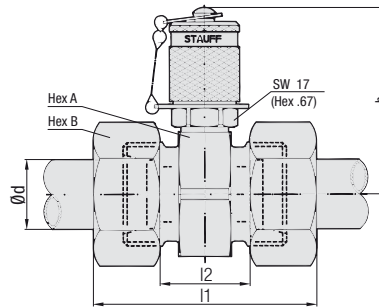

▪ Compression ring fittings acc. to ISO 8434-1 / DIN 2353

Metal Parts

Standard material: Steel, zinc/nickel-plated = **C6F (CrVI-free)**
 For ordering V2A (1.4305 / AISI 303) replace "C6F" with "V2A".
 For ordering V4A (1.4571 / AISI 316Ti) replace "C6F" with "V4A".

Sealings

For ordering FPM sealings replace "P" with "V".
 For ordering EPDM sealings replace "P" with "E".

* **Standard option for North America is FPM (Viton®).**

Protection Cap

Standard material: Steel
 For ordering the hexagonal protection cap version please add "-SK" to the order code. (e.g. SMK20-08L-PG-SK-C6F)
 For ordering the plastic protection cap version please add "-KK" to the order code. (e.g. SMK20-08L-PG-KK-C6F)

For further information on materials, sealings or protection caps, please see page B4.

Series	PN (^{mm} / _{rs})	Pipe Ø d	Dimensions (^{mm} / _m)					Order Codes	
			~I1	I2	h	Hex A	Hex B	NBR	FPM* (Standard Option-North America)
L	315 4568	6	51	21	49	24	14	SMK20-06L-PG-C6F	SMK20-06L-VG-C6F
			2.01	.83	1.93	.94	.55		
		8	51	21	49	24	17	SMK20-08L-PG-C6F	SMK20-08L-VG-C6F
			2.01	.83	1.93	.94	.67		
		10	53	23	49	24	19	SMK20-10L-PG-C6F	SMK20-10L-VG-C6F
			2.09	.91	1.93	.94	.75		
	12	53	23	50,5	27	22	SMK20-12L-PG-C6F	SMK20-12L-VG-C6F	
		2.09	.91	1.99	1.06	.87			
	15	55	25	52	30	27	SMK20-15L-PG-C6F	SMK20-15L-VG-C6F	
		2.17	.98	2.05	1.18	1.06			
	18	57	24	53	32	32	SMK20-18L-PG-C6F	SMK20-18L-VG-C6F	
		2.24	.94	2.09	1.26	1.26			
160 2320	22	61	28	55	36	36	SMK20-22L-PG-C6F	SMK20-22L-VG-C6F	
		2.40	1.10	2.17	1.42	1.42			
	28	61	28	57,5	41	41	SMK20-28L-PG-C6F	SMK20-28L-VG-C6F	
		2.40	1.10	2.26	1.61	1.61			
35	69	26	60	46	50	SMK20-35L-PG-C6F	SMK20-35L-VG-C6F		
	2.72	1.02	2.36	1.81	1.97				
42	71	25	64,5	55	60	SMK20-42L-PG-C6F	SMK20-42L-VG-C6F		
	2.80	.98	2.54	2.17	2.36				
S	630 9137	6	55	25	49	24	17	SMK20-06S-PG-C6F	SMK20-06S-VG-C6F
			2.17	.98	1.93	.94	.67		
		8	55	25	49	24	19	SMK20-08S-PG-C6F	SMK20-08S-VG-C6F
			2.17	.98	1.93	.94	.75		
		10	57	24	49	24	22	SMK20-10S-PG-C6F	SMK20-10S-VG-C6F
			2.24	.94	1.93	.94	.87		
	12	57	24	49	24	24	SMK20-12S-PG-C6F	SMK20-12S-VG-C6F	
		2.24	.94	1.93	.94	.94			
	14	63	27	50,5	27	27	SMK20-14S-PG-C6F	SMK20-14S-VG-C6F	
		2.50	1.06	1.99	1.06	1.06			
	400 5801	16	63	26	52	30	30	SMK20-16S-PG-C6F	SMK20-16S-VG-C6F
			2.50	1.02	2.05	1.18	1.18		
		20	69	26	55	36	36	SMK20-20S-PG-C6F	SMK20-20S-VG-C6F
			2.72	1.02	2.17	1.42	1.42		
		25	75	27	57,5	41	46	SMK20-25S-PG-C6F	SMK20-25S-VG-C6F
			2.95	1.06	2.26	1.61	1.81		
	30	81	28	60	46	50	SMK20-30S-PG-C6F	SMK20-30S-VG-C6F	
		3.19	1.10	2.36	1.81	1.97			
315 4568	38	91	29	64,5	55	60	SMK20-38S-PG-C6F	SMK20-38S-VG-C6F	
		3.58	1.14	2.54	2.17	2.36			

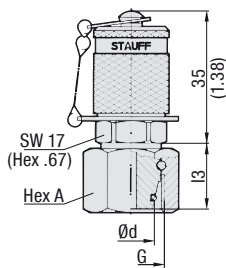

Version A

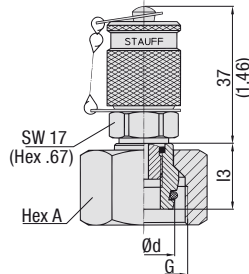

Version B

Test Coupling for 24° Cone Fittings SMK20 Type K



Series	PN (bar / psi)	Pipe Ø d	Dimensions (mm / in)		Thread	Version	Order Codes	
			I3	Hex A			NBR	FPM* (Standard Option-North America)
L	315 4568	6	15,5	14	M12 x 1,5	A	SMK20-06L-PK-C6F	SMK20-06L-VK-C6F
			.61	.55				
		8	15,5	17	M14 x 1,5	A	SMK20-08L-PK-C6F	SMK20-08L-VK-C6F
			.61	.67				
		10	16,5	19	M16 x 1,5	A	SMK20-10L-PK-C6F	SMK20-10L-VK-C6F
			.65	.75				
	12	17,5	22	M18 x 1,5	A	SMK20-12L-PK-C6F	SMK20-12L-VK-C6F	
		.69	.87					
	160 2320	15	21	27	M22 x 1,5	B	SMK20-15L-PK-GS-C6F	SMK20-15L-VK-GS-C6F
			.83	1.06				
		18	19,5	32	M26 x 1,5	B	SMK20-18L-PK-GS-C6F	SMK20-18L-VK-GS-C6F
			.77	1.26				
22		20,5	36	M30 x 2	B	SMK20-22L-PK-GS-C6F	SMK20-22L-VK-GS-C6F	
		.81	1.42					
28	25	41	M36 x 2	B	SMK20-28L-PK-GS-C6F	SMK20-28L-VK-GS-C6F		
	.98	1.61						
35	30	50	M45 x 2	B	SMK20-35L-PK-GS-C6F	SMK20-35L-VK-GS-C6F		
	1.18	1.97						
42	31	60	M52 x 2	B	SMK20-42L-PK-GS-C6F	SMK20-42L-VK-GS-C6F		
	1.22	2.36						
S	630 9137	6	14,5	17	M14 x 1,5	A	SMK20-06S-PK-C6F	SMK20-06S-VK-C6F
			.57	.67				
		8	16,5	19	M16 x 1,5	A	SMK20-08S-PK-C6F	SMK20-08S-VK-C6F
			.65	.75				
		10	16,5	22	M18 x 1,5	A	SMK20-10S-PK-C6F	SMK20-10S-VK-C6F
	.65		.87					
	12	17,5	24	M20 x 1,5	A	SMK20-12S-PK-C6F	SMK20-12S-VK-C6F	
		.69	.94					
	14	19,5	27	M22 x 1,5	B	SMK20-14S-PK-GS-C6F	SMK20-14S-VK-GS-C6F	
		.77	1.06					
	400 5801	16	18	30	M24 x 1,5	B	SMK20-16S-PK-GS-C6F	SMK20-16S-VK-GS-C6F
			.71	1.18				
		20	24	36	M30 x 2	B	SMK20-20S-PK-GS-C6F	SMK20-20S-VK-GS-C6F
			.94	1.42				
		25	26	46	M36 x 2	B	SMK20-25S-PK-GS-C6F	SMK20-25S-VK-GS-C6F
1.02	1.81							
30	30	50	M42 x 2	B	SMK20-30S-PK-GS-C6F	SMK20-30S-VK-GS-C6F		
	1.18	1.97						
315 4568	38	34	60	M52 x 2	B	SMK20-38S-PK-GS-C6F	SMK20-38S-VK-GS-C6F	
		1.34	2.36					

- For DKO connection
- According to ISO 8434-1 / DIN 2353
- Version A: one-piece design
- Version B: screwed design

Metal Parts

Standard material: Steel, zinc/nickel-plated = **C6F (CrVI-free)**
 For ordering V2A (1.4305 / AISI 303) replace "C6F" with "V2A".
 For ordering V4A (1.4571 / AISI 316Ti) replace "C6F" with "V4A".

Sealings

For ordering FPM sealings replace "P" with "V".
 For ordering EPDM sealings replace "P" with "E".

* Standard option for North America is FPM (Viton®).

Protection Cap

Standard material: Steel
 For ordering the hexagonal protection cap version please add "-SK" to the order code. (e.g. SMK20-08L-PK-SK-C6F)
 For ordering the plastic protection cap version please add "-KK" to the order code. (e.g. SMK20-08L-PK-KK-C6F)

For further information on materials, sealings or protection caps, please see page B4.

**Test Coupling SMK-JIC Connection (to SAE-J514)
SMK20-JIC Type K**

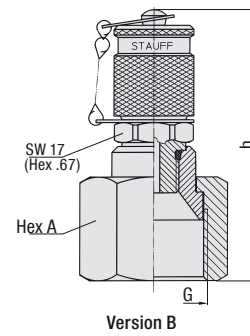
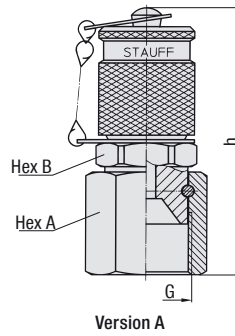

- 37° JIC fittings acc. to SAE J514
- Version A: one-piece design
- Version B: screwed design

Metal Parts

Standard material: Steel, zinc/nickel-plated = **C6F (CrVI-free)**
 For ordering V2A (1.4305 / AISI 303) replace "C6F" with "V2A".
 For ordering V4A (1.4571 / AISI 316Ti) replace "C6F" with "V4A".

Sealings

For ordering FPM sealings replace "P" with "V".
 For ordering EPDM sealings replace "P" with "E".

* Standard option for North America is FPM (Viton®).

Protection Cap

Standard material: Steel
 For ordering the hexagonal protection cap version please add "-SK" to the order code. (e.g. SMK20-JIC5/16-PK-SK-C6F)
 For ordering the plastic protection cap version please add "-KK" to the order code. (e.g. SMK20-JIC5/16-PK-KK-C6F)

Pipe Ø d inch	JIC Size	Dimensions (mm/in)			Thread G	Version	Order Codes NBR	FPM* (Standard Option-North America)
		h	Hex A	Hex B				
1/4	-4	53	17	17	7/16-20 UNF	A	SMK20-JIC1/4-PK-C6F	SMK20-JIC1/4-VK-C6F
		2.09	.67	.67				
5/16	-5	53,5	17	17	1/2-20 UNF	A	SMK20-JIC5/16-PK-C6F	SMK20-JIC5/16-VK-C6F
		2.11	.67	.67				
3/8	-6	55,5	19	17	9/16-18 UNF	A	SMK20-JIC3/8-PK-C6F	SMK20-JIC3/8-VK-C6F
		2.19	.75	.67				
1/2	-8	56,5	22	19	3/4-16 UNF	A	SMK20-JIC1/2-PK-C6F	SMK20-JIC1/2-VK-C6F
		2.22	.87	.75				
5/8	-10	60	27	22	7/8-14 UNF	A	SMK20-JIC5/8-PK-C6F	SMK20-JIC5/8-VK-C6F
		2.36	1.06	.87				
3/4	-12	70,5	32	-	1-1/16-12 UN	B	SMK20-JIC3/4-PK-GS-C6F	SMK20-JIC3/4-VK-GS-C6F
		2.78	1.26	-				
1	-16	69	38	-	1-5/16-12 UN	B	SMK20-JIC1-PK-GS-C6F	SMK20-JIC1-VK-GS-C6F
		2.72	1.50	-				
1-1/4	-20	73,5	50	-	1-5/8-12 UN	B	SMK20-JIC1-1/4-PK-GS-C6F	SMK20-JIC1-1/4-VK-GS-C6F
		2.89	1.97	-				
1-1/2	-24	76	60	-	1-7/8-12 UN	B	SMK20-JIC1-1/2-PK-GS-C6F	SMK20-JIC1-1/2-VK-GS-C6F
		2.99	2.36	-				

For further information on materials, sealings or protection caps, please see page B4.

**Test Coupling SMK-JIC Connection (to SAE-J514)
SMK20-JIC Type G**

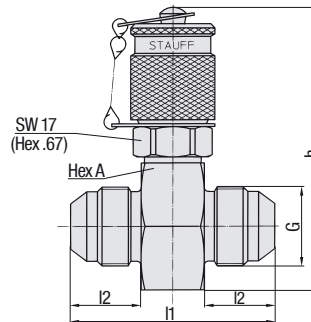

- 37° JIC fittings acc. to SAE J514

Metal Parts

Standard material: Steel, zinc/nickel-plated = **C6F (CrVI-free)**
 For ordering V2A (1.4305 / AISI 303) replace "C6F" with "V2A".
 For ordering V4A (1.4571 / AISI 316Ti) replace "C6F" with "V4A".

Sealings

For ordering FPM sealings replace "P" with "V".
 For ordering EPDM sealings replace "P" with "E".

* Standard option for North America is FPM (Viton®).

Protection Cap

Standard material: Steel
 For ordering the hexagonal protection cap version please add "-SK" to the order code. (e.g. SMK20-JIC5/16-PG-SK-C6F)
 For ordering the plastic protection cap version please add "-KK" to the order code. (e.g. SMK20-JIC5/16-PG-KK-C6F)

Pipe Ø d inch	JIC Size	Dimensions (mm/in)				Thread G	Order Codes NBR	FPM* (Standard Option-North America)
		I1	I2	h	Hex A			
1/4	-4	43	14	61	24	7/16-20 UNF	SMK20-JIC1/4-PG-C6F	SMK20-JIC1/4-VG-C6F
		1.69	.55	2.40	.94			
5/16	-5	43	14	61	24	1/2-20 UNF	SMK20-JIC5/16-PG-C6F	SMK20-JIC5/16-VG-C6F
		1.69	.55	2.40	.94			
3/8	-6	43	14	61	24	9/16-18 UNF	SMK20-JIC3/8-PG-C6F	SMK20-JIC3/8-VG-C6F
		1.69	.55	2.40	.94			
1/2	-8	48,5	16,5	67	30	3/4-16 UNF	SMK20-JIC1/2-PG-C6F	SMK20-JIC1/2-VG-C6F
		1.91	.65	2.64	1.18			
5/8	-10	53,5	19,5	67	30	7/8-14 UNF	SMK20-JIC5/8-PG-C6F	SMK20-JIC5/8-VG-C6F
		2.11	.77	2.64	1.18			
3/4	-12	59	22	73	36	1-1/16-12 UN	SMK20-JIC3/4-PG-C6F	SMK20-JIC3/4-VG-C6F
		2.32	.87	2.87	1.42			
1	-16	61	23	78	41	1-5/16-12 UN	SMK20-JIC1-PG-C6F	SMK20-JIC1-VG-C6F
		2.40	.91	3.07	1.61			
1-1/4	-20	65,5	24,5	83	46	1-5/8-12 UN	SMK20-JIC1-1/4-PG-C6F	SMK20-JIC1-1/4-VG-C6F
		2.58	.96	3.26	1.81			
1-1/2	-24	72	27,5	92	55	1-7/8-12 UN	SMK20-JIC1-1/2-PG-C6F	SMK20-JIC1-1/2-VG-C6F
		2.83	1.08	3.62	2.17			

For further information on materials, sealings or protection caps, please see page B4.

Swivel Run Tee with JIC Connection SGV-JIC Type F/M

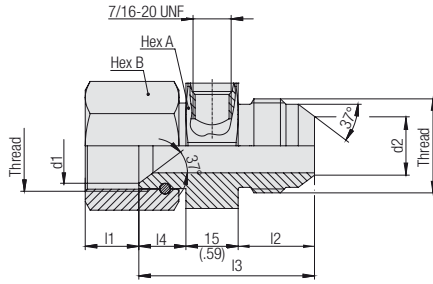

Thread	Dimensions (mm/in)								Order Codes	
	inch	Ø d1	Ø d2	l1	l2	l3	l4	Hex A		Hex B
7/16-20 UNF		7,49	4,9	9	14	37	8	27	17	SGV-7/16UNF-04-JIC1/4-F/M-C6F
		.29	.19	.35	.55	1.46	.31	1.06	.67	
9/16-18 UNF		11,05	8,1	10,5	14	37,5	8,5	27	19	SGV-7/16UNF-06-JIC3/8-F/M-C6F
		.44	.32	.41	.55	1.48	.33	1.06	.75	
3/4-16 UNF		15,9	10,8	10,5	16,7	43,7	12	30	22	SGV-7/16UNF-08-JIC1/2-F/M-C6F
		.63	.43	.41	.66	1.72	.47	1.18	.87	
1-1/16-12 UN		21,6	16,9	15,4	21,9	50,4	13,5	36	32	SGV-7/16UNF-12-JIC3/4-F/M-C6F
		.85	.66	.61	.86	1.98	.53	1.42	1.26	
1-5/16-12 UN		27,9	23,2	17,3	23,1	53,1	15	41	41	SGV-7/16UNF-16-JIC1-F/M-C6F
		1.10	.91	.68	.91	2.09	.59	1.61	1.61	

Metal Parts

Standard material: Steel, zinc/nickel-plated = **C6F (CrVI-free)**
 For ordering V2A (1.4305 / AISI 303) replace "C6F" with "V2A".
 For ordering V4A (1.4571 / AISI 316Ti) replace "C6F" with "V4A".

For further information please consult STAUFF.

Test Coupling with ORFS Connection SMK20 Type ORFS

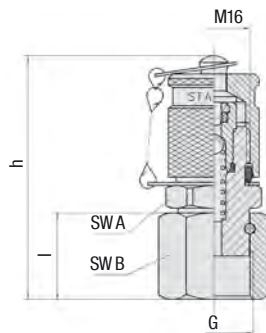

Thread	Dimensions (mm/in)				Order Codes		
	G	h	l	Hex A	Hex B	NBR	FPM* (Standard Option-North America)
9/16-18 UNF		54	19	17	17	SMK20-04-ORFS-P-C6F	SMK20-04-ORFS-V-C6F
		2.1	.75	.67	.67		
11/16-16 UN		54	19	19	21	SMK20-06-ORFS-P-C6F	SMK20-06-ORFS-V-C6F
		2.1	.75	.75	.80		
13/16-16 UN		54	19	22	24	SMK20-08-ORFS-P-C6F	SMK20-08-ORFS-V-C6F
		2.1	.75	.87	.87		

Metal Parts

Standard material: Steel, zinc/nickel-plated = **C6F (CrVI-free)**
 For ordering V2A (1.4305 / AISI 303) replace "C6F" with "V2A".
 For ordering V4A (1.4571 / AISI 316Ti) replace "C6F" with "V4A".

Sealings

For ordering FPM sealings replace "P" with "V".
 For ordering EPDM sealings replace "P" with "E".

* Standard option for North America is FPM (Viton®).

Protection Cap

Standard material: Steel
 For ordering the hexagonal protection cap version please add
 "-SK" to the order code. (e.g. SMK20-04-ORFS-P-SK-C6F)
 For ordering the plastic protection cap version please add
 "-KK" to the order code. (e.g. SMK20-04-ORFS-P-KK-C6F)

For further information on materials, sealings or protection caps, please see page B4.

**Bulkhead
SSK20**

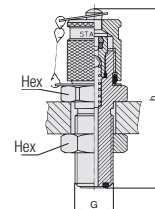
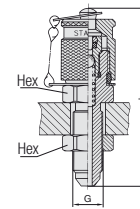
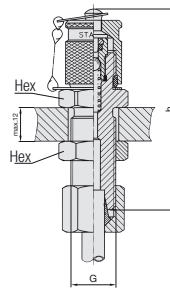
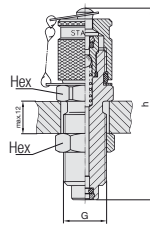

Version A

Version B

Version C

Version D

▪ Also available for gaseous media Type SSKK

Threads

*1 Compression ring assembly 08L/ 08S/ 12L according to ISO 8434-1 / DIN 2353

*2 JIC cone fitting according to SAE J514

*3 O-ring face sealing according to SAE J1453

Metal Parts

Standard material: Steel, zinc/nickel-plated = **C6F (CrVI-free)**

For ordering V2A (1.4305 / AISI 303) replace "C6F" with "V2A".

For ordering V4A (1.4571 / AISI 316Ti) replace "C6F" with "V4A".

Sealings

For ordering FPM sealings replace "P" with "V".

For ordering EPDM sealings replace "P" with "E".

* **Standard option for North America is FPM (Viton®).**

Protection Cap

Standard material: Steel

For ordering the hexagonal protection cap version please add

"-SK" to the order code. (e.g. SKK20-P-SK-C6F)

For ordering the plastic protection cap version please add

"-KK" to the order code. (e.g. SKK20-P-KK-C6F)

For further information on materials, sealings or protection caps, please see page B4.

Note: Standard option version B without compression ring and nut.

Thread	Dimensions (mm/in)		Version	Order Codes NBR	FPM* (Standard Option-North America)
	G	h			
M16	72	19	A	SSK20-P-C6F	SSK20-V-C6F
	2.83	.75			
M14 x 1,5*1	72	19	B	SSK20/08L-P-C6F	SSK20/08L-V-C6F
	2.83	.75			
M16 x 1,5*1	72	22	B	SSK20/08S-P-C6F	SSK20/08S-V-C6F
	2.83	.87			
M18 x 1,5*1	72	22	B	SSK20/12L-P-C6F	SSK20/12L-V-C6F
	2.83	.87			
7/16-20 UNF*2	66	17	C	SSK20/J7/16UNF-MV-P-C6F	SSK20/J7/16UNF-MV-V-C6F
	2.60	.67			
9/16-18 UNF*3	67	22	D	SSK20-04-ORFS-P-C6F	SSK20-04-ORFS-V-C6F
	2.64	.87			
11/16-16 UNF*3	72	27	D	SSK20-06-ORFS-P-C6F	SSK20-06-ORFS-V-C6F
	2.83	1.06			
13/16-16 UNF*3	75	30	D	SSK20-08-ORFS-P-C6F	SSK20-08-ORFS-V-C6F
	2.95	1.18			

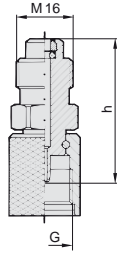
**Adaptor
SAD20**

Version A

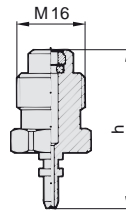

Version B



Thread	Dimensions (mm/in)		Version	Order Codes	
	G	h		NBR	FPM* (Standard Option-North America)
M16 x 1,5	39	1.54	A	SAD20/15-P-C6F	SAD20/15-V-C6F
S12*1	39	1.54	A	SAD20/12-P-C6F	SAD20/12-V-C6F
Plug in	37	1.46	B	SAD20/10-P-C6F	SAD20/10-V-C6F

Threads

*1 Special thread: buttress thread S12.65 x1,5

Metal Parts

Standard material: Steel, zinc/nickel-plated = **C6F (CrVI-free)**
 For ordering V2A (1.4305 / AISI 303) replace "C6F" with "V2A".
 For ordering V4A (1.4571 / AISI 316Ti) replace "C6F" with "V4A".

Sealings

For ordering FPM sealings replace "P" with "V".
 For ordering EPDM sealings replace "P" with "E".

* Standard option for North America is FPM (Viton®).

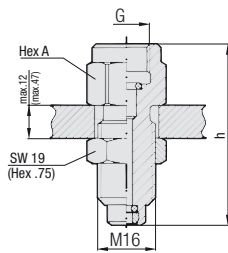

Through hole
Ø 18 (.71)

Gauge Adaptor SMA20

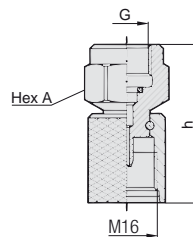

Direct Gauge Adaptor SMD20

Gauge Adaptor SMA20 Direct Gauge Adaptor SMD20

Thread	Dimensions (mm/in)			Order Codes	
	G	h	Hex A	NBR	FPM* (Standard Option-North America)
G1/4	54	19	.75	SMA20-G1/4-P-OR-C6F	SMA20-G1/4-V-OR-C6F
G1/2	64	27	1.06	SMA20-G1/2-P-OR-C6F	SMA20-G1/2-V-OR-C6F
1/4 NPT	54	19	.75	SMA20-1/4NPT-P-C6F	SMA20-1/4NPT-V-C6F
1/2 NPT	64	27	1.06	SMA20-1/2NPT-P-C6F	SMA20-1/2NPT-V-C6F
7/16-20 UNF	54	19	.75	SMA20-7/16UNF-PC6F	SMA20-7/16UNF-V-C6F
9/16-18 UNF	57	19	.75	SMA20-9/16UNF-P-C6F	SMA20-9/16UNF-V-C6F
G1/4	41	19	.75	SMD20-G1/4-P-OR-C6F	SMD20-G1/4-V-OR-C6F
G1/2	51	27	1.06	SMD20-G1/2-P-OR-C6F	SMD20-G1/2-V-OR-C6F
1/4 NPT	41	19	.75	SMD20-1/4NPT-C6F	
1/2 NPT	51	27	1.06	SMD20-1/2NPT-C6F	
7/16-20 UNF	41	19	.75	SMD20-7/16UNF-C6F	
9/16-18 UNF	43	19	.75	SMD20-9/16UNF-C6F	

Metal Parts

Standard material: Steel, zinc/nickel-plated = **C6F (CrVI-free)**
 For ordering V2A (1.4305 / AISI 303) replace "C6F" with "V2A".
 For ordering V4A (1.4571 / AISI 316Ti) replace "C6F" with "V4A".

Sealings

For ordering FPM sealings replace "P" with "V".
 For ordering EPDM sealings replace "P" with "E".

* Standard option for North America is FPM (Viton®).

Snubber on request.

Test Coupling with Piston Valve

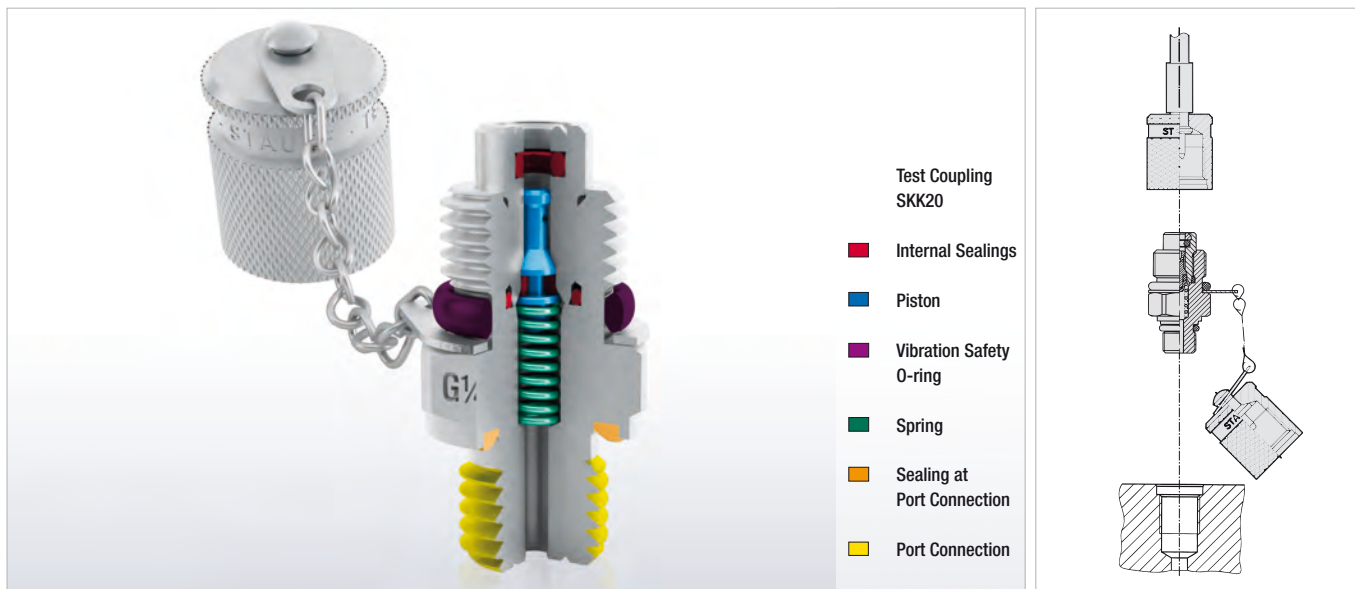

Fast coupling for

- Monitoring and control of pressure
- Venting
- Sampling in high- and low-pressure systems
- Filling of accumulators (special filling-version)

Advantages

- Test system at working pressure
- Leakproof connection before **piston valve** is open
- Simple connection to measurement, control and switching devices
- Self locking metal protective cap

Working Pressure

- Max. working pressure 630 bar / 9137 PSI
For SKK Type G and K the recommended working pressure of fitting manufacturer should be noted.
- Connection under pressure up to 400 bar / 5801 PSI max.

DVGW

- DVGW registration as test coupling for gas pressure control systems with the Deutsche Vereinigung des Gas- und Wasserfaches e.V.
- The DVGW approval relates solely to the SKK12 and SKK20 series with connection types:
 - M8x1-VA-DVGW
 - M10x1-VA-DVGW
 - 1/8NPT-VD-DVGW
 - 1/4NPT-VD-DVGW

Media

- Suitable for hydraulic oils and other Mineral oil based fluids (Check compatibility of sealing material)
- For use with other liquid media please consult STAUFF
- In case of ultimate tightness requirements for gaseous media, a special Gas-type is available

Materials

- **Metal Parts:**
Standard material: Steel, zinc/nickel-plated = **C6F (CrVI-free)**
Optional:
Stainless Steel **V2A** (1.4305 / AISI 303) on request
Stainless Steel **V4A** (1.4571 / AISI 316Ti) on request

For ordering "V2A" or "V4A" please replace "C6F" with "V2A" or "V4A".

- **Sealings:**
P = NBR (Buna-N®)
(Temperature range -20 °C ... +100 °C / -4 °F ... +212 °F)
Note: Internal sealings made of FPM, even for standard NBR-type.

V = FPM (Viton®)*
(Temperature range -20 °C ... +200 °C / -4 °F ... +392 °F)

*** Standard option for North America is FPM (Viton®)**

E = EPDM Ethylene Propylene Diene Monomer Rubber
(for Brake fluid,
Temperature range -40 °C ... +150 °C / -40 °F ... +302 °F)

For ordering FPM or EPDM sealings please replace "P" with "V" or "E".

Vibration safety O-ring made of NBR (Buna-N®) (standard).

Protection Cap

- The complete STAUFF-Test-20-Type-SKK range is also available with a hexagonal protection cap made of steel or plastic protection cap.

For ordering the hexagonal protection cap version please add "-SK" to the order code. (e.g. SKK20-M10x1-PA-SK-C6F)
For ordering the plastic protection cap version please add "-KK" to the order code. (e.g. SKK20-M10x1-PA-KK-C6F)

SKK20
Test Coupling
with Port Connection



SKK20 Type G
Test Coupling complete
with Straight Fitting



SKK20 Type K
Test Coupling for
24° Cone Fittings

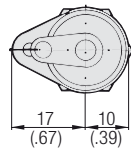
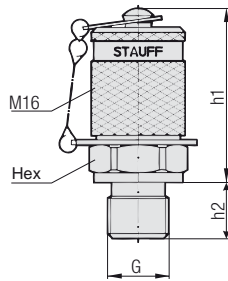

**Test Coupling with Port Connection
SKK20**

Thread G	Sealing	Working Pressure (bar / psi)	Dimensions (mm / in)			Order Codes	
			h1	h2	Hex	NBR	FPM* (Standard Option-North America)
M8 x 1	Type A	250	38	8,5	17	SKK20-M8x1-PA-C6F	SKK20-M8x1-VA-C6F
		3625	1.50	.33	.67		
		630	38	9,8	17		
M10 x 1	Type A	9137	1.50	.39	.67	SKK20-M10x1-PA-C6F	SKK20-M10x1-VA-C6F
		630	37	12	17	SKK20-M12x1,5-PB-C6F	SKK20-M12x1,5-VB-C6F
M12 x 1,5	Type B	9137	1.46	.47	.67	SKK20-M14x1,5-PB-C6F	SKK20-M14x1,5-VB-C6F
		630	37	12	19	SKK20-M16x1,5-PB-C6F	SKK20-M16x1,5-VB-C6F
M14 x 1,5	Type B	9137	1.46	.47	.75	SKK20-M16x1,5-PB-C6F	SKK20-M16x1,5-VB-C6F
		630	37	12	22	SKK20-G1/4-PB-C6F	SKK20-G1/4-VB-C6F
M16 x 1,5	Type B	9137	1.46	.47	.87	SKK20-G3/8-PB-C6F	SKK20-G3/8-VB-C6F
		630	37	12	19	SKK20-M10x1-PC-C6F	SKK20-M10x1-VC-C6F
G1/4	Type C	9137	1.46	.47	.75	SKK20-M12x1,5-PC-C6F	SKK20-M12x1,5-VC-C6F
		630	37	12	17	SKK20-M14x1,5-PC-C6F	SKK20-M14x1,5-VC-C6F
G3/8	Type C	9137	1.46	.47	.75	SKK20-M16x1,5-PC-C6F	SKK20-M16x1,5-VC-C6F
		630	37	12	22	SKK20-G1/8-PC-C6F	SKK20-G1/8-VC-C6F
M10 x 1	Type C	5801	1.54	.31	.67	SKK20-G1/4-PC-C6F	SKK20-G1/4-VC-C6F
		630	37	12	17	SKK20-G3/8-PC-C6F	SKK20-G3/8-VC-C6F
M12 x 1,5	Type C	9137	1.46	.47	.67	SKK20-G1/2-PC-C6F	SKK20-G1/2-VC-C6F
		630	37	12	19	SKK20-R1/8K-PD-C6F	SKK20-R1/8K-VD-C6F
M14 x 1,5	Type C	9137	1.46	.47	.75	SKK20-R1/4K-PD-C6F	SKK20-R1/4K-VD-C6F
		630	37	12	22	SKK20-1/8NPT-PD-C6F	SKK20-1/8NPT-VD-C6F
M16 x 1,5	Type C	9137	1.46	.47	.87	SKK20-1/4NPT-PD-C6F	SKK20-1/4NPT-VD-C6F
		630	37	12	22	SKK20-5/16UNF-PE-C6F	SKK20-5/16UNF-VE-C6F
G1/8	Type D	5801	1.54	.31	.67	SKK20-7/16UNF-PE-C6F	SKK20-7/16UNF-VE-C6F
		630	37	12	17	SKK20-1/2UNF-PE-C6F	SKK20-1/2UNF-VE-C6F
G1/4	Type D	9137	1.46	.47	.75	SKK20-9/16UNF-PE-C6F	SKK20-9/16UNF-VE-C6F
		630	37	10	19	SKK20-M12x1,5-PE-C6F	SKK20-M12x1,5-VE-C6F
G3/8	Type D	9137	1.46	.47	.87	SKK20-M14x1,5-PE-C6F	SKK20-M14x1,5-VE-C6F
		630	37	11	17	SKK20-M14x1,5-PE-C6F	SKK20-M14x1,5-VE-C6F
G1/2	Type D	9137	1.54	.55	1.06		

Metal Parts

Standard material: Steel, zinc/nickel-plated = **C6F (CrVI-free)**
 For ordering V2A (1.4305 / AISI 303) replace "C6F" with "V2A".
 For ordering V4A (1.4571 / AISI 316Ti) replace "C6F" with "V4A".

Sealings

For ordering FPM sealings replace "P" with "V".
 For ordering EPDM sealings replace "P" with "E".

* Standard option for North America is FPM (Viton®).

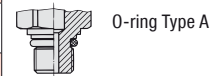
Sealing Details

O-ring Type A



Metal Joint Type B



Elastomeric Sealing Type C

 Taper Type D
 (suitable sealant required)

O-ring Type E

Protection Cap

Standard material: Steel
 For ordering the hexagonal protection cap version please add "-SK" to the order code. (e.g. SKK20-M10x1-PA-SK-C6F)
 For ordering the plastic protection cap version please add "-KK" to the order code. (e.g. SKK20-M10x1-PA-KK-C6F)

For further information on materials, sealings or protection caps, please see page B12.

Other port connections and sealings on request.
 Please consult STAUFF for further information.

**Test Coupling complete with Straight Fitting
SKK20 Type G**

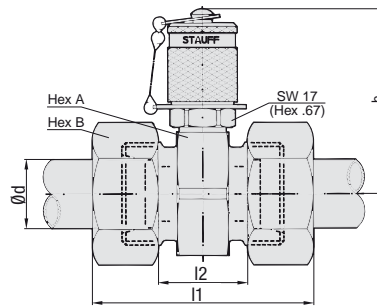

▪ Compression ring fittings acc. to ISO 8434-1 / DIN 2353

Metal Parts

Standard material: Steel, zinc/nickel-plated = **C6F (CrVI-free)**
 For ordering V2A (1.4305 / AISI 303) replace "C6F" with "V2A".
 For ordering V4A (1.4571 / AISI 316Ti) replace "C6F" with "V4A".

Sealings

For ordering FPM sealings replace "P" with "V".
 For ordering EPDM sealings replace "P" with "E".

* **Standard option for North America is FPM (Viton®).**

Protection Cap

Standard material: Steel
 For ordering the hexagonal protection cap version please add "-SK" to the order code. (e.g. SKK20-08L-PG-SK-C6F)
 For ordering the plastic protection cap version please add "-KK" to the order code. (e.g. SKK20-08L-PG-KK-C6F)

For further information on materials, sealings or protection caps, please see page B12.

Series	PN (^{mm} /ps)	Pipe Ød	Dimensions (mm /in)					Order Codes	
			~l1	l2	h	Hex A	Hex B	NBR	FPM* (Standard Option-North America)
L	315 4568	6	51	21	49	24	14	SKK20-06L-PG-C6F	SKK20-06L-VG-C6F
			2.01	.83	1.93	.94	.55		
		8	51	21	49	24	17	SKK20-08L-PG-C6F	SKK20-08L-VG-C6F
			2.01	.83	1.93	.94	.67		
		10	53	23	49	24	19	SKK20-10L-PG-C6F	SKK20-10L-VG-C6F
			2.09	.91	1.93	.94	.75		
	12	53	23	50,5	27	22	SKK20-12L-PG-C6F	SKK20-12L-VG-C6F	
		2.09	.91	1.99	1.06	.87			
	15	55	25	52	30	27	SKK20-15L-PG-C6F	SKK20-15L-VG-C6F	
		2.17	.98	2.05	1.18	1.06			
	18	57	24	53	32	32	SKK20-18L-PG-C6F	SKK20-18L-VG-C6F	
		2.24	.94	2.09	1.26	1.26			
160 2320	22	61	28	55	36	36	SKK20-22L-PG-C6F	SKK20-22L-VG-C6F	
		2.40	1.10	2.17	1.42	1.42			
	28	61	28	57,5	41	41	SKK20-28L-PG-C6F	SKK20-28L-VG-C6F	
		2.40	1.10	2.26	1.61	1.61			
35	69	26	60	46	50	SKK20-35L-PG-C6F	SKK20-35L-VG-C6F		
	2.72	1.02	2.36	1.81	1.97				
42	71	25	64,5	55	60	SKK20-42L-PG-C6F	SKK20-42L-VG-C6F		
	2.80	.98	2.54	2.17	2.36				
S	630 9137	6	55	25	49	24	17	SKK20-06S-PG-C6F	SKK20-06S-VG-C6F
			2.17	.98	1.93	.94	.67		
		8	55	25	49	24	19	SKK20-08S-PG-C6F	SKK20-08S-VG-C6F
			2.17	.98	1.93	.94	.75		
		10	57	24	49	24	22	SKK20-10S-PG-C6F	SKK20-10S-VG-C6F
			2.24	.94	1.93	.94	.87		
	12	57	24	49	24	24	SKK20-12S-PG-C6F	SKK20-12S-VG-C6F	
		2.24	.94	1.93	.94	.94			
	14	63	27	50,5	27	27	SKK20-14S-PG-C6F	SKK20-14S-VG-C6F	
		2.50	1.06	1.99	1.06	1.06			
	400 5801	16	63	26	52	30	30	SKK20-16S-PG-C6F	SKK20-16S-VG-C6F
			2.50	1.02	2.05	1.18	1.18		
		20	69	26	55	36	36	SKK20-20S-PG-C6F	SKK20-20S-VG-C6F
			2.72	1.02	2.17	1.42	1.42		
		25	75	27	57,5	41	46	SKK20-25S-PG-C6F	SKK20-25S-VG-C6F
			2.95	1.06	2.26	1.61	1.81		
	30	81	28	60	46	50	SKK20-30S-PG-C6F	SKK20-30S-VG-C6F	
		3.19	1.10	2.36	1.81	1.97			
315 4568	38	91	29	64,5	55	60	SKK20-38S-PG-C6F	SKK20-38S-VG-C6F	
		3.58	1.14	2.54	2.17	2.36			

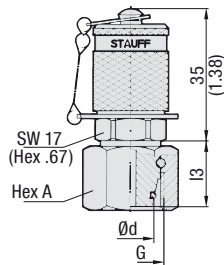

Version A

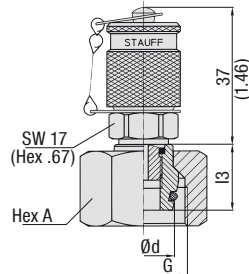

Version B

Test Coupling for 24° Cone Fittings SKK20 Type K



Series	PN (bar / psi)	Pipe Ød	Dimensions (mm / in)			Thread	Version	Order Codes	
			I3	Hex A	G			NBR	FPM* (Standard Option-North America)
L	315 4568	6	15,5	14	M12 x 1,5	A	SKK20-06L-PK-C6F	SKK20-06L-VK-C6F	
			.61	.55					
		8	15,5	17	M14 x 1,5	A	SKK20-08L-PK-C6F	SKK20-08L-VK-C6F	
			.61	.67					
		10	16,5	19	M16 x 1,5	A	SKK20-10L-PK-C6F	SKK20-10L-VK-C6F	
			.65	.75					
	12	17,5	22	M18 x 1,5	A	SKK20-12L-PK-C6F	SKK20-12L-VK-C6F		
		.69	.87						
	15	21	27	M22 x 1,5	B	SKK20-15L-PK-GS-C6F	SKK20-15L-VK-GS-C6F		
		.83	1.06						
	18	19,5	32	M26 x 1,5	B	SKK20-18L-PK-GS-C6F	SKK20-18L-VK-GS-C6F		
		.77	1.26						
160 2320	22	20,5	36	M30 x 2	B	SKK20-22L-PK-GS-C6F	SKK20-22L-VK-GS-C6F		
		.81	1.42						
	28	25	41	M36 x 2	B	SKK20-28L-PK-GS-C6F	SKK20-28L-VK-GS-C6F		
		.98	1.61						
35	30	50	M45 x 2	B	SKK20-35L-PK-GS-C6F	SKK20-35L-VK-GS-C6F			
	1.18	1.97							
42	31	60	M52 x 2	B	SKK20-42L-PK-GS-C6F	SKK20-42L-VK-GS-C6F			
	1.22	2.36							
S	630 9137	6	14,5	17	M14 x 1,5	A	SKK20-06S-PK-C6F	SKK20-06S-VK-C6F	
			.57	.67					
		8	16,5	19	M16 x 1,5	A	SKK20-08S-PK-C6F	SKK20-08S-VK-C6F	
			.65	.75					
		10	16,5	22	M18 x 1,5	A	SKK20-10S-PK-C6F	SKK20-10S-VK-C6F	
	.65		.87						
	12	17,5	24	M20 x 1,5	A	SKK20-12S-PK-C6F	SKK20-12S-VK-C6F		
		.69	.94						
	14	19,5	27	M22 x 1,5	B	SKK20-14S-PK-GS-C6F	SKK20-14S-VK-GS-C6F		
		.77	1.06						
	400 5801	16	18	30	M24 x 1,5	B	SKK20-16S-PK-GS-C6F	SKK20-16S-VK-GS-C6F	
			.71	1.18					
		20	24	36	M30 x 2	B	SKK20-20S-PK-GS-C6F	SKK20-20S-VK-GS-C6F	
			.94	1.42					
		25	26	46	M36 x 2	B	SKK20-25S-PK-GS-C6F	SKK20-25S-VK-GS-C6F	
1.02	1.81								
30	30	50	M42 x 2	B	SKK20-30S-PK-GS-C6F	SKK20-30S-VK-GS-C6F			
	1.18	1.97							
315 4568	38	34	60	M52 x 2	B	SKK20-38S-PK-GS-C6F	SKK20-38S-VK-GS-C6F		
		1.34	2.36						

- For DKO connection
- According to ISO 8434-1 / DIN 2353
- Version A: one-piece design
- Version B: screwed design

Metal Parts

Standard material: Steel, zinc/nickel-plated = **C6F (CrVI-free)**
 For ordering V2A (1.4305 / AISI 303) replace "C6F" with "V2A".
 For ordering V4A (1.4571 / AISI 316Ti) replace "C6F" with "V4A".

Sealings

For ordering FPM sealings replace "P" with "V".
 For ordering EPDM sealings replace "P" with "E".

* Standard option for North America is FPM (Viton®).

Protection Cap

Standard material: Steel
 For ordering the hexagonal protection cap version please add "-SK" to the order code. (e.g. SKK20-08L-PK-SK-C6F)
 For ordering the plastic protection cap version please add "-KK" to the order code. (e.g. SKK20-08L-PK-KK-C6F)

For further information on materials, sealings or protection caps, please see page B12.

Test Coupling with Ball Check

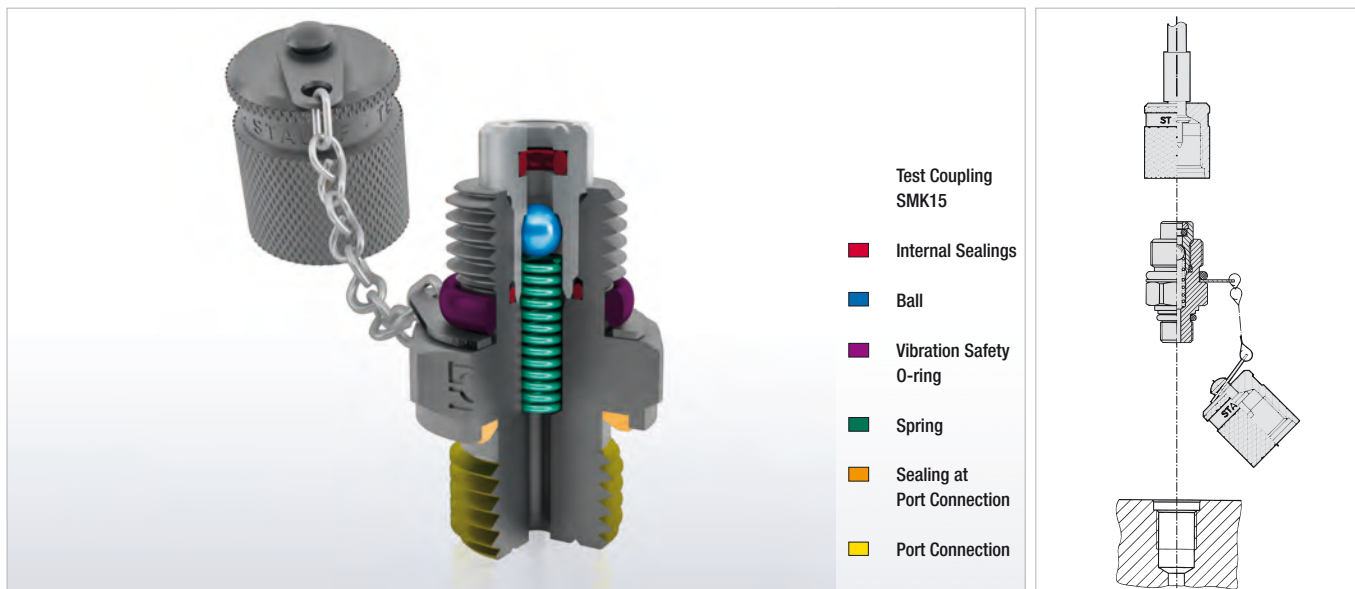

Fast coupling for

- Monitoring and control of pressure
- Venting
- Sampling in high- and low-pressure systems

Advantages

- Test system at working pressure
- Leak proof connection before **ball check** is open
- Simple connection to measurement, control and switching devices
- Self locking metal protective cap

Working Pressure

- Max. working pressure 630 bar / 9137 PSI
For SMK Type G and K the recommended working pressure of fitting manufacturer should be noted.
- Connection under pressure up to 630 bar / 9137 PSI max.

Materials

- **Metal parts:**
Standard material: Steel, black zinc/nickel-plated = **C6F*** (CrVI-free)
Optional:
Stainless Steel **V2A** (1.4305 / AISI 303) on request
Stainless Steel **V4A** (1.4571 / AISI 316Ti) on request

For ordering V2A or V4A please replace "C6F" with "V2A" or "V4A".

* Note: The changeover of our standard surface finishing "zinc plated" to the chromium (VI) free surface finishing "black zinc/nickel-plated" will proceed gradually.

- **Ball:** Stainless Steel

Sealings:

P = NBR (Buna-N®)

(Temperature range -20 °C ... +100 °C / -4 °F ... +212 °F)

Note: Internal sealings made of FPM, even for standard NBR-type.

V = FPM (Viton®)*

(Temperature range -20 °C ... +200 °C / -4 °F ... +392 °F)

*** Standard option for North America is FPM (Viton®)**

E = EPDM Ethylene Propylene Diene Monomer Rubber

(for Brake fluid,

Temperature range -40 °C ... +150 °C / -40 °F ... +302 °F)

For ordering FPM or EPDM sealings please replace "P" with "V" or "E".

Vibration safety O-ring made of NBR (Buna-N®) (standard).

Media

- Suitable for hydraulic oils and other Mineral oil based fluid (Check compatibility of seal material)
- For use with other liquid media please consult STAUFF

Protection Cap

- The complete STAUFF-Test-15-Type-SMK range is also available with a hexagonal protection cap made of steel.

For ordering the hexagonal protection cap version please add "-SK" to the order code. (e.g. SMK15-M10x1-PA-SK-C6F)

Note

- On request TEST 15 is also available as SKK-type including "Gas"- and "Filling"-versions.

SMK15 Test Coupling with Port Connection	SMK15 Type G Test Coupling complete with Straight Fitting	SMK15 Type K Test Coupling for 24° Cone Fittings	SSK15 Bulkhead
			

Test Coupling with Port Connection SMK15

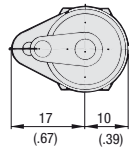
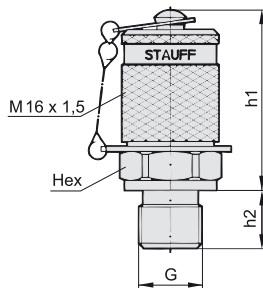

Thread G	Sealing	Working Pressure (^{bar} / _{psi})	Dimensions (^{mm} / _{in})			Order Codes	
			h1	h2	Hex	NBR	FPM* (Standard Option-North America)
M10 x 1	Type A	630	38	9,8	17	SMK15-M10x1-PA-C6F	SMK15-M10x1-VA-C6F
		9137	1.50	.39	.67		
M14 x 1,5		630	37	12	19	SMK15-M14x1,5-PB-C6F	SMK15-M14x1,5-VB-C6F
		9137	1.46	.47	.75		
M16 x 1,5		630	37	12	22	SMK15-M16x1,5-PB-C6F	SMK15-M16x1,5-VB-C6F
		9137	1.46	.47	.87		
G1/8	Type B	400	39	8	17	SMK15-G1/8-PB-C6F	SMK15-G1/8-VB-C6F
		5801	1.54	.31	.67		
G1/4		630	37	12	19	SMK15-G1/4-PB-C6F	SMK15-G1/4-VB-C6F
		9137	1.46	.47	.75		
G3/8		630	37	12	22	SMK15-G3/8-PB-C6F	SMK15-G3/8-VB-C6F
		9137	1.46	.47	.87		
M12 x 1,5		630	37	12	17	SMK15-M12x1,5-PC-C6F	SMK15-M12x1,5-VC-C6F
		9137	1.46	.47	.67		
M14 x 1,5		630	37	12	19	SMK15-M14x1,5-PC-C6F	SMK15-M14x1,5-VC-C6F
		9137	1.46	.47	.75		
M16 x 1,5	Type C	630	37	12	22	SMK15-M16x1,5-PC-C6F	SMK15-M16x1,5-VC-C6F
		9137	1.46	.47	.87		
G1/8		400	39	8	17	SMK15-G1/8-PC-C6F	SMK15-G1/8-VC-C6F
		5801	1.54	.31	.67		
G1/4		630	37	12	19	SMK15-G1/4-PC-C6F	SMK15-G1/4-VC-C6F
		9137	1.46	.47	.75		
R1/4 K		630	35	12	17	SMK15-R1/4K-PD-C6F	SMK15-R1/4K-VD-C6F
		9137	1.38	.47	.67		
1/8 NPT	Type D	400	36	10	17	SMK15-1/8NPT-PD-C6F	SMK15-1/8NPT-VD-C6F
		5801	1.42	.39	.67		
1/4 NPT		630	35	15	17	SMK15-1/4NPT-PD-C6F	SMK15-1/4NPT-VD-C6F
		9137	1.38	.59	.67		
7/16-20 UNF		630	38	9,1	17	SMK15-7/16UNF-PE-C6F	SMK15-7/16UNF-VE-C6F
		9137	1.50	.36	.67		
9/16-18 UNF	Type E	630	37	10	19	SMK15-9/16UNF-PE-C6F	SMK15-9/16UNF-VE-C6F
		9137	1.46	.39	.75		
M14 x 1,5		630	38	11	19	SMK15-M14x1,5-PE-C6F	SMK15-M14x1,5-VE-C6F
		9137	1.50	.43	.75		

Metal Parts

Standard material:

Steel, black zinc/nickel-plated = **C6F (CrVI-free)**

For ordering V2A (1.4305 / AISI 303) replace "C6F" with "V2A".

For ordering V4A (1.4571 / AISI 316Ti) replace "C6F" with "V4A".

Sealings

For ordering FPM sealings replace "P" with "V".

For ordering EPDM sealings replace "P" with "E".

* Standard option for North America is FPM (Viton®).

Sealing Details



O-ring Type A



Metal Joint Type B



Elastomeric Sealing Type C



Taper Type D
(suitable sealant required)



O-ring Type E

Protection Cap

Standard material: Steel

For ordering the hexagonal protection cap version please add

"-SK" to the order code. (e.g. SMK15-M10x1-PA-SK-C6F)

For further information on materials, seals or protection caps, please see page B16.

Other port connections and seals on request.
Please consult STAUFF for further information.

**Test Coupling complete with Straight Fitting
SMK15 Type G**

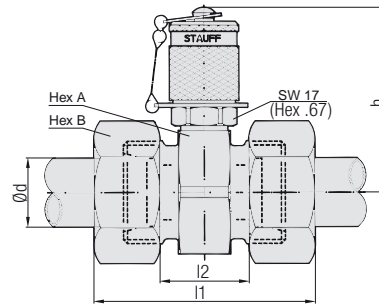

- Compression ring fittings acc. to ISO 8434-1 / DIN 2353

Metal Parts

Standard material:

- Test coupling: Steel, black zinc/nickel-plated = **C6F (CrVI-free)**
 - Straight fitting: Steel, zinc/nickel-plated = **C6F (CrVI-free)**
- For ordering V2A (1.4305 / AISI 303) replace "C6F" with "V2A".
For ordering V4A (1.4571 / AISI 316Ti) replace "C6F" with "V4A".

Sealings

For ordering FPM sealings replace "P" with "V".
For ordering EPDM sealings replace "P" with "E".

* Standard option for North America is FPM (Viton®).

Protection Cap

Standard material: Steel
For ordering the hexagonal protection cap version please add "-SK" to the order code. (e.g. SMK15-08L-PG-SK-C6F)

For further information on materials, sealings or protection caps, please see page B16.

Series	PN (bar/psi)	Pipe Ød	Dimensions (mm/in)					Order Codes NBR	FPM* (Standard Option-North America)
			~l1	l2	h	Hex A	Hex B		
L	315 4568	6	51	21	49	24	14	SMK15-06L-PG-C6F	SMK15-06L-VG-C6F
			2.01	.83	1.93	.94	.55		
		8	51	21	49	24	17	SMK15-08L-PG-C6F	SMK15-08L-VG-C6F
			2.01	.83	1.93	.94	.67		
		10	53	23	49	24	19	SMK15-10L-PG-C6F	SMK15-10L-VG-C6F
			2.09	.91	1.93	.94	.75		
	12	53	23	50,5	27	22	SMK15-12L-PG-C6F	SMK15-12L-VG-C6F	
		2.09	.91	1.99	1.06	.87			
	15	55	25	52	30	27	SMK15-15L-PG-C6F	SMK15-15L-VG-C6F	
		2.17	.98	2.05	1.18	1.06			
	18	57	24	53	32	32	SMK15-18L-PG-C6F	SMK15-18L-VG-C6F	
		2.24	.94	2.09	1.26	1.26			
160 2320	22	61	28	55	36	36	SMK15-22L-PG-C6F	SMK15-22L-VG-C6F	
		2.40	1.10	2.17	1.42	1.42			
	28	61	28	57,5	41	41	SMK15-28L-PG-C6F	SMK15-28L-VG-C6F	
		2.40	1.10	2.26	1.61	1.61			
	35	69	26	60	46	50	SMK15-35L-PG-C6F	SMK15-35L-VG-C6F	
2.72		1.02	2.36	1.81	1.97				
42	71	25	64,5	55	60	SMK15-42L-PG-C6F	SMK15-42L-VG-C6F		
		2.80	.98	2.54	2.17	2.36			
S	630 9137	6	55	25	49	24	17	SMK15-06S-PG-C6F	SMK15-06S-VG-C6F
			2.17	.98	1.93	.94	.67		
		8	55	25	49	24	19	SMK15-08S-PG-C6F	SMK15-08S-VG-C6F
			2.17	.98	1.93	.94	.75		
		10	57	24	49	24	22	SMK15-10S-PG-C6F	SMK15-10S-VG-C6F
			2.24	.94	1.93	.94	.87		
	12	57	24	49	24	24	SMK15-12S-PG-C6F	SMK15-12S-VG-C6F	
		2.24	.94	1.93	.94	.94			
	14	63	27	50,5	27	27	SMK15-14S-PG-C6F	SMK15-14S-VG-C6F	
		2.50	1.06	1.99	1.06	1.06			
	400 5801	16	63	26	52	30	30	SMK15-16S-PG-C6F	SMK15-16S-VG-C6F
			2.50	1.02	2.05	1.18	1.18		
20		69	26	55	36	36	SMK15-20S-PG-C6F	SMK15-20S-VG-C6F	
		2.72	1.02	2.17	1.42	1.42			
25		75	27	57,5	41	46	SMK15-25S-PG-C6F	SMK15-25S-VG-C6F	
	2.95	1.06	2.26	1.61	1.81				
30	81	28	60	46	50	SMK15-30S-PG-C6F	SMK15-30S-VG-C6F		
		3.19	1.10	2.36	1.81	1.97			
315 4568	38	91	29	64,5	55	60	SMK15-38S-PG-C6F	SMK15-38S-VG-C6F	
		3.58	1.14	2.54	2.17	2.36			

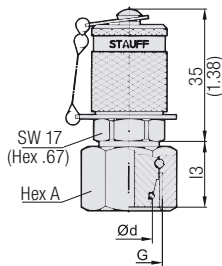

Version A

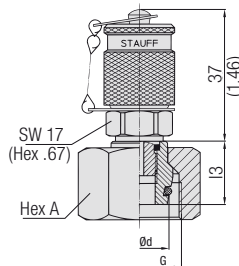

Version B

Test Coupling for 24° Cone Fittings SMK15 Type K



Series	PN (bar/psi)	Pipe Ød	Dimensions (mm/in)		Thread G	Version	Order Codes	
			I3	Hex A			NBR	FPM* (Standard Option-North America)
L	315 4568	6	15,5 .61	14 .55	M12 x 1,5	A	SMK15-06L-PK-C6F	SMK15-06L-VK-C6F
		8	15,5 .61	17 .67	M14 x 1,5	A	SMK15-08L-PK-C6F	SMK15-08L-VK-C6F
		10	16,5 .65	19 .75	M16 x 1,5	A	SMK15-10L-PK-C6F	SMK15-10L-VK-C6F
		12	17,5 .69	22 .87	M18 x 1,5	A	SMK15-12L-PK-C6F	SMK15-12L-VK-C6F
		15	21 .83	27 1.06	M22 x 1,5	B	SMK15-15L-PK-GS-C6F	SMK15-15L-VK-GS-C6F
		18	19,5 .77	32 1.26	M26 x 1,5	B	SMK15-18L-PK-GS-C6F	SMK15-18L-VK-GS-C6F
	160 2320	22	20,5 .81	36 1.42	M30 x 2	B	SMK15-22L-PK-GS-C6F	SMK15-22L-VK-GS-C6F
		28	25 .98	41 1.61	M36 x 2	B	SMK15-28L-PK-GS-C6F	SMK15-28L-VK-GS-C6F
		35	30 1.18	50 1.97	M45 x 2	B	SMK15-35L-PK-GS-C6F	SMK15-35L-VK-GS-C6F
		42	31 1.22	60 2.36	M52 x 2	B	SMK15-42L-PK-GS-C6F	SMK15-42L-VK-GS-C6F
S	630 9137	6	14,5 .57	17 .67	M14 x 1,5	A	SMK15-06S-PK-C6F	SMK15-06S-VK-C6F
		8	16,5 .65	19 .75	M16 x 1,5	A	SMK15-08S-PK-C6F	SMK15-08S-VK-C6F
		10	16,5 .65	22 .87	M18 x 1,5	A	SMK15-10S-PK-C6F	SMK15-10S-VK-C6F
		12	17,5 .69	24 .94	M20 x 1,5	A	SMK15-12S-PK-C6F	SMK15-12S-VK-C6F
		14	19,5 .77	27 1.06	M22 x 1,5	B	SMK15-14S-PK-GS-C6F	SMK15-14S-VK-GS-C6F
	400 5801	16	18 .71	30 1.18	M24 x 1,5	B	SMK15-16S-PK-GS-C6F	SMK15-16S-VK-GS-C6F
		20	24 .94	36 1.42	M30 x 2	B	SMK15-20S-PK-GS-C6F	SMK15-20S-VK-GS-C6F
		25	26 1.02	46 1.81	M36 x 2	B	SMK15-25S-PK-GS-C6F	SMK15-25S-VK-GS-C6F
		30	30 1.18	50 1.97	M42 x 2	B	SMK15-30S-PK-GS-C6F	SMK15-30S-VK-GS-C6F
		315 4568	38	34 1.34	60 2.36	M52 x 2	B	SMK15-38S-PK-GS-C6F

- For DKO connection
- According to ISO 8434-1 / DIN 2353
- Version A: one-piece design
- Version B: screwed design

Metal Parts

Standard material:

- Test coupling: Steel, black zinc/nickel-plated = C6F (CrVI-free)
 - 24° cone fittings: Steel, zinc/nickel-plated = C6F (CrVI-free)
- For ordering V2A (1.4305 / AISI 303) replace "C6F" with "V2A".
For ordering V4A (1.4571 / AISI 316Ti) replace "C6F" with "V4A".

Sealings

For ordering FPM sealings replace "P" with "V".
For ordering EPDM sealings replace "P" with "E".

* Standard option for North America is FPM (Viton®).

Protection Cap

Standard material: Steel
For ordering the hexagonal protection cap version please add "-SK" to the order code. (e.g. SMK15-08L-PK-SK-C6F)

For further information on materials, sealings or protection caps, please see page B16.

**Bulkhead
SSK15**

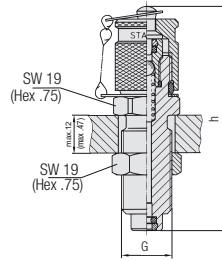

Version A

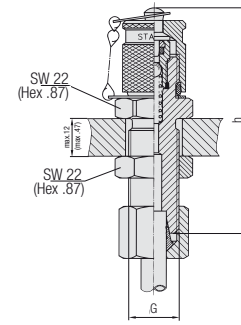

Version B

▪ Also available for gaseous media type SSKK

Threads

*1 Compression ring assembly 08S according to ISO 8434-1 / DIN 2353

Thread	Dimensions (mm/in)	Version	Order Codes	
			NBR	FPM* (Standard Option-North America)
M16 x 1,5	72	A	SSK15-P-C6F	SSK15-V-C6F
	2.83			
M16 x 1,5 *1	72	B	SSK15/08S-P-C6F	SSK15/08S-V-C6F
	2.83			

Metal Parts

Standard material version A:

- Test coupling: Steel, **black zinc/nickel-plated = C6F (CrVI-free)**

Standard material version B:

- Test coupling: Steel, **black zinc/nickel-plated = C6F (CrVI-free)**
- Hex nut: Steel, zinc/nickel-plated = **C6F (CrVI-free)**

For ordering V2A (1.4305 / AISI 303) replace "C6F" with "V2A".
For ordering V4A (1.4571 / AISI 316Ti) replace "C6F" with "V4A".

Sealings

For ordering FPM sealings replace "P" with "V".
For ordering EPDM sealings replace "P" with "E".

* Standard option for North America is FPM (Viton®).

Protection Cap

Standard material: Steel

For ordering the hexagonal protection cap version please add "-SK" to the order code. (e.g. SSK15-P-SK-C6F)

For further information on materials, sealings or protection caps, please see page B16.

Note: Standard option version B without compression ring and nut.

**Swivel Run Tee with JIC Connection
SGV-JIC Type F/M**

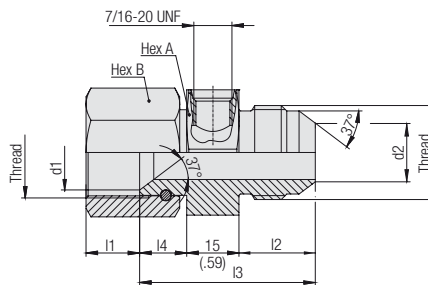

Metal Parts

Standard material: Steel, zinc/nickel-plated = **C6F (CrVI-free)**

For ordering V2A (1.4305 / AISI 303) replace "C6F" with "V2A".
For ordering V4A (1.4571 / AISI 316Ti) replace "C6F" with "V4A".

For further information please consult STAUFF.

Thread	Dimensions (mm/in)								Order Codes
inch	Ø d1	Ø d2	l1	l2	l3	l4	Hex A	Hex B	
7/16-20 UNF	7,49	4,9	9	14	37	8	27	17	SGV-7/16UNF-04-JIC1/4-F/M-C6F
	.29	.19	.35	.55	1.46	.31	1.06	.67	
9/16-18 UNF	11,05	8,1	10,5	14	37,5	8,5	27	19	SGV-7/16UNF-06-JIC3/8-F/M-C6F
	.44	.32	.41	.55	1.48	.33	1.06	.75	
3/4-16 UNF	15,9	10,8	10,5	16,7	43,7	12	30	22	SGV-7/16UNF-08-JIC1/2-F/M-C6F
	.63	.43	.41	.66	1.72	.47	1.18	.87	
1-1/16-12 UN	21,6	16,9	15,4	21,9	50,4	13,5	36	32	SGV-7/16UNF-12-JIC3/4-F/M-C6F
	.85	.66	.61	.86	1.98	.53	1.42	1.26	
1-5/16-12 UN	27,9	23,2	17,3	23,1	53,1	15	41	41	SGV-7/16UNF-16-JIC1-F/M-C6F
	1.10	.91	.68	.91	2.09	.59	1.61	1.61	

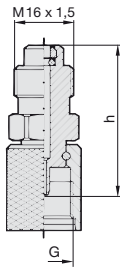
**Adaptor
SAD15**

Version A

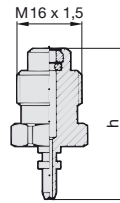

Version B



Thread	Dimensions (mm/in)	Version	Order Codes	
			NBR	FPM* (Standard Option-North America)
G	h			
M16 x 2	39 1.54	A	SAD15/20-P-C6F	SAD15/20-V-C6F
S12 *1	39 1.54	A	SAD15/12-P-C6F	SAD15/12-V-C6F
Plug in	37 1.46	B	SAD15/10-P-C6F	SAD15/10-V-C6F

Threads

*1 Special thread: buttress thread S12.65 x1,5

Metal Parts

Standard material version A:

- Threaded nipple: Steel, black zinc/nickel-plated = **C6F (CrVI-free)**
- Swivel nut: Steel, zinc/nickel-plated = **C6F (CrVI-free)**

Standard material version B:

Steel, black zinc/nickel-plated = **C6F (CrVI-free)**

For ordering V2A (1.4305 / AISI 303) replace "C6F" with "V2A".
For ordering V4A (1.4571 / AISI 316Ti) replace "C6F" with "V4A".

Sealings

For ordering FPM sealings replace "P" with "V".
For ordering EPDM sealings replace "P" with "E".

* Standard option for North America is FPM (Viton®).

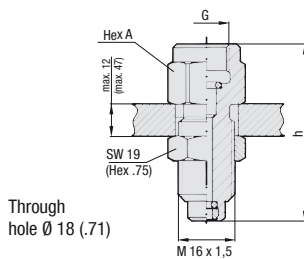

Gauge Adaptor SMA15

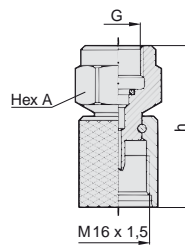

Direct Gauge Adaptor SMD15

Gauge Adaptor SMA15 Direct Gauge Adaptor SMD15

Thread	Dimensions (mm/in)		Order Codes	
	h	Hex A	NBR	FPM* (Standard Option-North America)
G1/4	54 2.13	19 .75	SMA15-G1/4-P-OR-C6F	SMA15-G1/4-V-OR-C6F
G1/2	64 2.52	27 1.06	SMA15-G1/2-P-OR-C6F	SMA15-G1/2-V-OR-C6F
1/4 NPT	54 2.13	19 .75	SMA15-1/4NPT-P-C6F	SMA15-1/4NPT-V-C6F
1/2 NPT	64 2.52	27 1.06	SMA15-1/2NPT-P-C6F	SMA15-1/2NPT-V-C6F
G1/4	41 1.61	19 .75	SMD15-G1/4-P-OR-C6F	SMD15-G1/4-V-OR-C6F
G1/2	51 2.01	27 1.06	SMD15-G1/2-P-OR-C6F	SMD15-G1/2-V-OR-C6F
1/4 NPT	41 1.61	19 .75	SMD15-1/4NPT-C6F	
1/2 NPT	51 2.01	27 1.06	SMD15-1/2NPT-C6F	

Metal Parts

Standard material SMA15:

Steel, black zinc/nickel-plated = **C6F (CrVI-free)**

Standard material SMD15:

▪ Gauge adaptor: Steel, zinc/nickel-plated = **C6F (CrVI-free)**

▪ Swivel nut: Steel, black zinc/nickel-plated = **C6F (CrVI-free)**

For ordering V2A (1.4305 / AISI 303) replace "C6F" with "V2A".
For ordering V4A (1.4571 / AISI 316Ti) replace "C6F" with "V4A".

Sealings

For ordering FPM sealings replace "P" with "V".
For ordering EPDM sealings replace "P" with "E".

* Standard option for North America is FPM (Viton®).

Snubber on request.

Test Coupling with Piston Valve

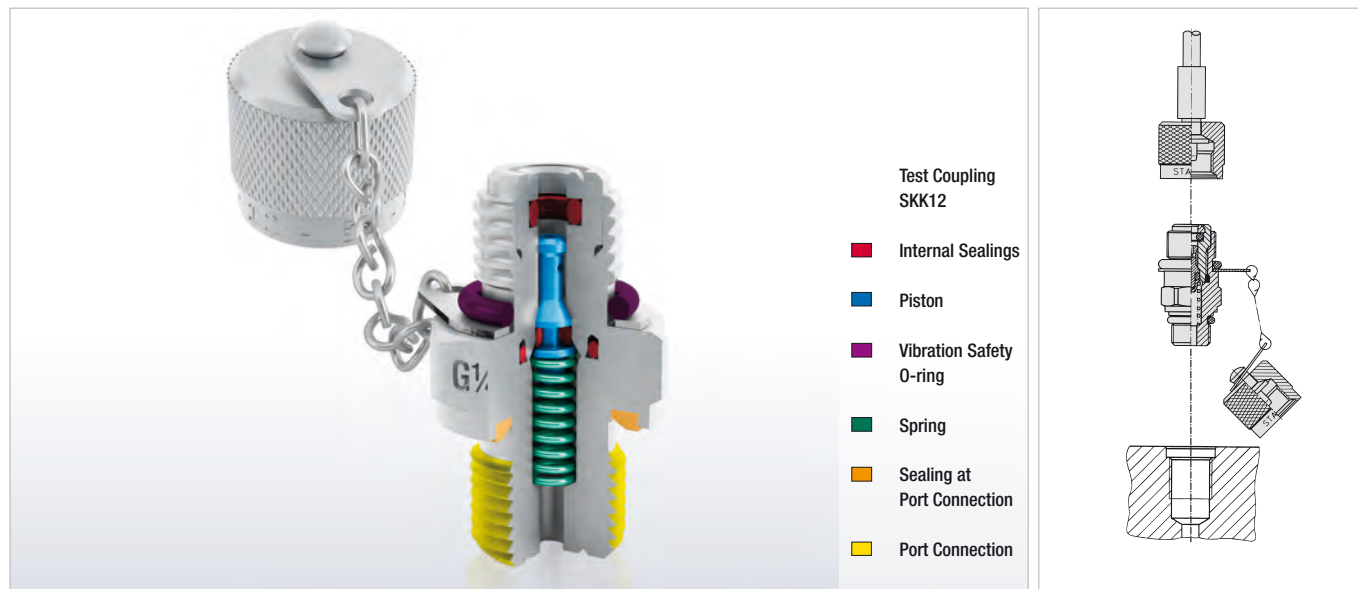

Fast Coupling for

- Monitoring and control of pressure
- Venting
- Sampling in high- and low-pressure systems
- Filling of accumulators (special filling-version)

Advantages

- Test system at working pressure
- Leak proof connection before **piston valve** is open
- Simple connection to measurement, control and switching devices
- Self locking metal protective cap

Working Pressure

- Max. working pressure 630 bar/ 9137 PSI
For SKK Type G and K the recommended working pressure of fitting manufacturer should be noted.
- Connection under pressure up to 400 bar / 5801 PSI max.

DVGW

- DVGW registration as test coupling for gas pressure control systems with the Deutsche Vereinigung des Gas- und Wasserfaches e.V.
- The DVGW approval relates solely to the SKK12 and SKK20 series with connection types:
 - M8x1-VA-DVGW
 - M10x1-VA-DVGW
 - 1/8NPT-VD-DVGW
 - 1/4NPT-VD-DVGW

Materials

- Metal Parts:**
Standard material: Steel, zinc/nickel-plated = **C6F (CrVI-free)**
Optional:
Stainless Steel **V2A** (1.4305 / AISI 303) on request
Stainless Steel **V4A** (1.4571 / AISI 316Ti) on request

For ordering "V2A" or "V4A" please replace "C6F" with "V2A" or "V4A".

Sealings:

P = NBR (Buna-N®)

(Temperature range -20 °C ... +100°C / -4 °F ... +212 °F)

Note: Internal sealings made of FPM, even for standard NBR-type.

V = FPM (Viton®)*

(Temperature range -20 °C ... +200 °C / -4 °F ... +392 °F)

*** Standard option for North America is FPM (Viton®)**

E = EPDM Ethylene Propylene Diene Monomer Rubber

(for Brake fluid,

Temperature range -40 °C ... +150 °C / -40 °F ... +302 °F)

For ordering FPM or EPDM sealings please replace "P" with "V" or "E".

Vibration safety O-ring made of NBR (Buna-N®) (standard).

Media

- Suitable for hydraulic oils and other Mineral oil based fluids (Check compatibility of seal material)
- For use with other liquid media please consult STAUFF
- In case of ultimate tightness requirements for gaseous media, a special Gas-type is available

Protection Cap

- The complete STAUFF-Test-12-type-SKK range is also available with a plastic protection cap.

For ordering the plastic protection cap version please add "-KK" to the order code. (e.g. SKK12-M10x1-PA-KK-C6F)

SKK12 Test Coupling with Port Connection	SKK12 Type G Test Coupling complete with Straight Fitting	SKK12 Type K Test Coupling for 24° Cone Fittings	SSKK12 Bulkhead
			

Test Coupling with Port Connection SKK12

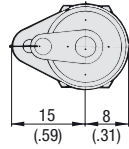
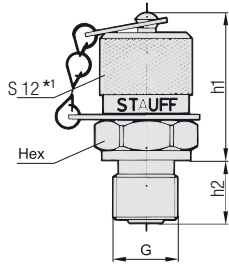

Thread G	Sealing	Working Pressure (bar / psi)	Dimensions (mm / in)			Order Codes	
			h1	h2	Hex	NBR	FPM* (Standard Option-North America)
M8 x 1	Type A	250	38	8,5	14	SKK12-M8x1-PA-C6F	SKK12-M8x1-VA-C6F
		3625	1.50	.33	.55		
		630	35	9,8	14		
M10 x 1	Type A	9137	1.38	.39	.67	SKK12-M10x1-PA-C6F	SKK12-M10x1-VA-C6F
		630	31	12	17		
		9137	1.22	.47	.67		
M12 x 1,5	Type B	630	31	12	19	SKK12-M12x1,5-PB-C6F	SKK12-M12x1,5-VB-C6F
		9137	1.22	.47	.75		
		630	31	12	22		
M14 x 1,5	Type B	9137	1.22	.47	.75	SKK12-M14x1,5-PB-C6F	SKK12-M14x1,5-VB-C6F
		630	30	12	19		
		9137	1.18	.47	.75		
M16 x 1,5	Type B	630	31	12	22	SKK12-M16x1,5-PB-C6F	SKK12-M16x1,5-VB-C6F
		9137	1.22	.47	.87		
		630	30	12	19		
G1/4	Type B	9137	1.18	.47	.75	SKK12-G1/4-PB-C6F	SKK12-G1/4-VB-C6F
		630	31	12	22		
		9137	1.22	.47	.87		
G3/8	Type B	630	31	12	22	SKK12-G3/8-PB-C6F	SKK12-G3/8-VB-C6F
		9137	1.22	.47	.87		
		630	31	12	17		
M12 x 1,5	Type C	9137	1.22	.47	.67	SKK12-M12x1,5-PC-C6F	SKK12-M12x1,5-VC-C6F
		400	40	8	14		
		5801	1.57	.31	.55		
G1/8	Type C	630	31	12	19	SKK12-G1/8-PC-C6F	SKK12-G1/8-VC-C6F
		9137	1.22	.47	.75		
		400	33	8	17		
R1/8 K	Type D	5801	1.30	.31	.55	SKK12-R1/8K-PD-C6F	SKK12-R1/8K-VD-C6F
		630	30	12	17		
		9137	1.18	.47	.55		
R1/4 K	Type D	400	33	10	14	SKK12-R1/4K-PD-C6F	SKK12-R1/4K-VD-C6F
		5801	1.30	.39	.55		
		630	28	15	14		
1/8 NPT	Type D	9137	1.10	.59	.55	SKK12-1/8NPT-PD-C6F	SKK12-1/8NPT-VD-C6F
		400	33	10	14		
		5801	1.30	.39	.55		
1/4 NPT	Type D	630	28	15	14	SKK12-1/4NPT-PD-C6F	SKK12-1/4NPT-VD-C6F
		9137	1.10	.59	.55		
		400	38	7,5	14		
5/16-24 UNF	Type E	5801	1.50	.30	.55	SKK12-5/16UNF-PE-C6F	SKK12-5/16UNF-VE-C6F
		630	33	9,1	17		
		9137	1.30	.36	.67		
7/16-20 UNF	Type E	630	32	9,2	17	SKK12-7/16UNF-PE-C6F	SKK12-7/16UNF-VE-C6F
		9137	1.26	.36	.67		
		630	31	10	19		
1/2-20 UNF	Type E	9137	1.22	.39	.75	SKK12-1/2UNF-PE-C6F	SKK12-1/2UNF-VE-C6F
		630	31	10	19		
		9137	1.22	.39	.75		
9/16-18 UNF	Type E	630	32	11	17	SKK12-9/16UNF-PE-C6F	SKK12-9/16UNF-VE-C6F
		9137	1.26	.43	.67		
		630	32	11	17		
M12 x 1,5	Type E	9137	1.26	.43	.67	SKK12-M12x1,5-PE-C6F	SKK12-M12x1,5-VE-C6F

Threads

*1 Special thread: buttress thread S12,65 x 1,5

Metal Parts

Standard material: Steel, zinc/nickel-plated = **C6F (CrVI-free)**
 For ordering V2A (1.4305 / AISI 303) replace "C6F" with "V2A".
 For ordering V4A (1.4571 / AISI 316Ti) replace "C6F" with "V4A".

Sealings

For ordering FPM sealings replace "P" with "V".
 For ordering EPDM sealings replace "P" with "E".

* Standard option for North America is FPM (Viton®).

Sealing Details



O-ring Type A



Metal Joint Type B



Elastomeric Sealing Type C



Taper Type D
(suitable sealant required)



O-ring Type E

Protection Cap

Standard material: Steel

For ordering the plastic protection cap version please add "-KK" to the order code. (e.g. SKK12-M10x1-PA-KK-C6F)

For further information on materials, sealings or protection caps, please see page B22.

Other port connections and sealings on request.
 Please consult STAUFF for further information.

**Test Coupling complete with Straight Fitting
SKK12 Type G**

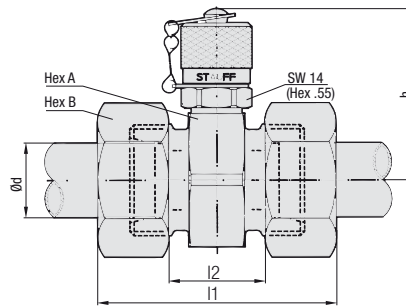

▪ Compression ring fittings acc. to ISO 8434-1 / DIN 2353

Metal Parts

Standard material: Steel, zinc/nickel-plated = **C6F (CrVI-free)**
 For ordering V2A (1.4305 / AISI 303) replace "C6F" with "V2A".
 For ordering V4A (1.4571 / AISI 316Ti) replace "C6F" with "V4A".

Sealings

For ordering FPM sealings replace "P" with "V".
 For ordering EPDM sealings replace "P" with "E".

* **Standard option for North America is FPM (Viton®).**

Protection Cap

Standard material: Steel
 For ordering the plastic protection cap version please add
 "-KK" to the order code. (e.g. SKK12-06L-PG-KK-C6F)

For further information on materials, sealings or protection caps, please see page B22.

Series	PN (^{mm} /ps)	Pipe Ød	Dimensions (^{mm} /in)					Order Codes	
			~I1	I2	h	Hex A	Hex B	NBR	FPM* (Standard Option-North America)
L	315 4568	6	51	21	46	24	14	SKK12-06L-PG-C6F	SKK12-06L-VG-C6F
			2.01	.83	1.81	.94	.55		
		8	51	21	46	24	17	SKK12-08L-PG-C6F	SKK12-08L-VG-C6F
			2.01	.83	1.81	.94	.67		
		10	53	23	46	24	19	SKK12-10L-PG-C6F	SKK12-10L-VG-C6F
			2.09	.91	1.81	.94	.75		
	12	53	23	47,5	27	22	SKK12-12L-PG-C6F	SKK12-12L-VG-C6F	
		2.09	.91	1.87	1.06	.87			
	15	55	25	49	30	27	SKK12-15L-PG-C6F	SKK12-15L-VG-C6F	
		2.17	.98	1.92	1.18	1.06			
	18	57	24	50	32	32	SKK12-18L-PG-C6F	SKK12-18L-VG-C6F	
		2.24	.94	1.97	1.26	1.26			
	160 2320	22	61	28	52	36	36	SKK12-22L-PG-C6F	SKK12-22L-VG-C6F
			2.40	1.10	2.05	1.42	1.42		
		28	61	28	54,5	41	41	SKK12-28L-PG-C6F	SKK12-28L-VG-C6F
			2.40	1.10	2.15	1.61	1.61		
35		69	26	57	46	50	SKK12-35L-PG-C6F	SKK12-35L-VG-C6F	
	2.72	1.02	2.24	1.81	1.97				
42	71	25	61,5	55	60	SKK12-42L-PG-C6F	SKK12-42L-VG-C6F		
	2.80	.98	2.42	2.17	2.36				
S	630 9137	6	55	25	46	24	17	SKK12-06S-PG-C6F	SKK12-06S-VG-C6F
			2.17	.98	1.81	.94	.67		
		8	55	25	46	24	19	SKK12-08S-PG-C6F	SKK12-08S-VG-C6F
			2.17	.98	1.81	.94	.75		
		10	57	24	46	24	22	SKK12-10S-PG-C6F	SKK12-10S-VG-C6F
			2.24	.94	1.81	.94	.87		
	12	57	24	46	24	24	SKK12-12S-PG-C6F	SKK12-12S-VG-C6F	
		2.24	.94	1.81	.94	.94			
	14	63	27	47,5	27	27	SKK12-14S-PG-C6F	SKK12-14S-VG-C6F	
		2.50	1.06	1.87	1.06	1.06			
	400 5801	16	63	26	49	30	30	SKK12-16S-PG-C6F	SKK12-16S-VG-C6F
			2.50	1.02	1.93	1.18	1.18		
		20	69	26	52	36	36	SKK12-20S-PG-C6F	SKK12-20S-VG-C6F
			2.72	1.02	2.05	1.42	1.42		
		25	75	27	54,5	41	46	SKK12-25S-PG-C6F	SKK12-25S-VG-C6F
	2.95		1.06	2.15	1.61	1.81			
	30	81	28	57	46	50	SKK12-30S-PG-C6F	SKK12-30S-VG-C6F	
		3.19	1.10	2.24	1.81	1.97			
315 4568	38	91	29	61,5	55	60	SKK12-38S-PG-C6F	SKK12-38S-VG-C6F	
3.58		1.14	2.42	2.17	2.36				

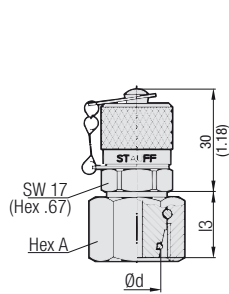

Version A

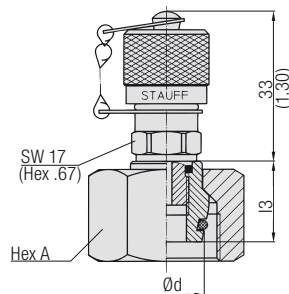

Version B

Test Coupling for 24° Cone Fittings SKK12 Type K



Series	PN (^{bar} /psi)	Pipe Ød	Dimensions (mm/in)		Thread G	Version	Order Codes	
			I3	Hex A			NBR	FPM* (Standard Option-North America)
L	315 4568	6	15,5	14	M12 x 1,5	A	SKK12-06L-PK-C6F	SKK12-06L-VK-C6F
			.61	.55				
		8	15,5	17	M14 x 1,5	A	SKK12-08L-PK-C6F	SKK12-08L-VK-C6F
			.61	.67				
		10	16,5	19	M16 x 1,5	A	SKK12-10L-PK-C6F	SKK12-10L-VK-C6F
			.65	.75				
	12	17,5	22	M18 x 1,5	A	SKK12-12L-PK-C6F	SKK12-12L-VK-C6F	
		.69	.87					
	160 2320	15	21	27	M22 x 1,5	B	SKK12-15L-PK-GS-C6F	SKK12-15L-VK-GS-C6F
			.83	1.06				
		18	19,5	32	M26 x 1,5	B	SKK12-18L-PK-GS-C6F	SKK12-18L-VK-GS-C6F
			.77	1.26				
22		20,5	36	M30 x 2	B	SKK12-22L-PK-GS-C6F	SKK12-22L-VK-GS-C6F	
		.81	1.42					
28	25	41	M36 x 2	B	SKK12-28L-PK-GS-C6F	SKK12-28L-VK-GS-C6F		
	.98	1.61						
35	30	50	M45 x 2	B	SKK12-35L-PK-GS-C6F	SKK12-35L-VK-GS-C6F		
	1.18	1.97						
42	31	60	M52 x 2	B	SKK12-42L-PK-GS-C6F	SKK12-42L-VK-GS-C6F		
	1.22	2.36						
S	630 9137	6	14,5	17	M14 x 1,5	A	SKK12-06S-PK-C6F	SKK12-06S-VK-C6F
			.57	.67				
		8	16,5	19	M16 x 1,5	A	SKK12-08S-PK-C6F	SKK12-08S-VK-C6F
			.65	.75				
		10	16,5	22	M18 x 1,5	A	SKK12-10S-PK-C6F	SKK12-10S-VK-C6F
	.65		.87					
	12	17,5	24	M20 x 1,5	A	SKK12-12S-PK-C6F	SKK12-12S-VK-C6F	
		.69	.94					
	400 5801	14	19,5	27	M22 x 1,5	B	SKK12-14S-PK-GS-C6F	SKK12-14S-VK-GS-C6F
			.77	1.06				
		16	18	30	M24 x 1,5	B	SKK12-16S-PK-GS-C6F	SKK12-16S-VK-GS-C6F
	.71		1.18					
	315 4568	20	24	36	M30 x 2	B	SKK12-20S-PK-GS-C6F	SKK12-20S-VK-GS-C6F
			.94	1.42				
		25	26	46	M36 x 2	B	SKK12-25S-PK-GS-C6F	SKK12-25S-VK-GS-C6F
1.02	1.81							
30	30	50	M42 x 2	B	SKK12-30S-PK-GS-C6F	SKK12-30S-VK-GS-C6F		
	1.18	1.97						
38	34	60	M52 x 2	B	SKK12-38S-PK-GS-C6F	SKK12-38S-VK-GS-C6F		
	1.34	2.36						

- For DKO connection
- According to ISO 8434-1 / DIN 2353
- Version A: one-piece design
- Version B: screwed design

Metal Parts

Standard material: Steel, zinc/nickel-plated = **C6F (CrVI-free)**
 For ordering V2A (1.4305 / AISI 303) replace "C6F" with "V2A".
 For ordering V4A (1.4571 / AISI 316Ti) replace "C6F" with "V4A".

Sealings

For ordering FPM sealings replace "P" with "V".
 For ordering EPDM sealings replace "P" with "E".

* Standard option for North America is FPM (Viton®).

Protection Cap

Standard material: Steel
 For ordering the plastic protection cap version please add
 "-KK" to the order code. (e.g. SKK12-06L-PK-KK-C6F)

For further information on materials, sealings or protection caps, please see page B22.

**Bulkhead
SSKK12**

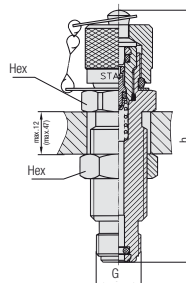

Threads

*1 Special thread: buttress thread S12,65 x 1,5

Metal Parts

Standard material: Steel, zinc/nickel-plated = **C6F (CrVI-free)**
 For ordering V2A (1.4305 / AISI 303) replace "C6F" with "V2A".
 For ordering V4A (1.4571 / AISI 316Ti) replace "C6F" with "V4A".

Sealings

For ordering FPM sealings replace "P" with "V".
 For ordering EPDM sealings replace "P" with "E".

* Standard option for North America is FPM (Viton®).

Protection Cap

Standard material: Steel
 For ordering the plastic protection cap version please add "-KK" to the order code. (e.g. SSKK12-P-KK-C6F)

For further information on materials, sealings or protection caps, please see page B22.

Thread	Dimensions (mm/in)		Order Codes NBR	FPM* (Standard Option-North America)
	G	Hex		
S12*1	63	19	SSKK12-P-C6F	SSKK12-V-C6F
	2.48	0.75		

**Swivel Run Tee with JIC Connection
SGV-JIC Type F/M**

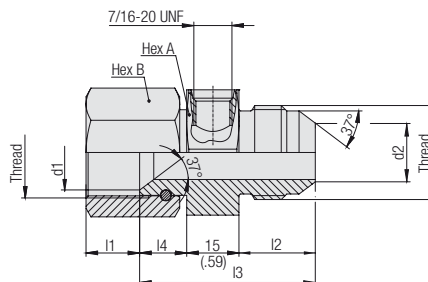

Metal Parts

Standard material: Steel, zinc/nickel-plated = **C6F (CrVI-free)**
 For ordering V2A (1.4305 / AISI 303) replace "C6F" with "V2A".
 For ordering V4A (1.4571 / AISI 316Ti) replace "C6F" with "V4A".

For further information please consult STAUFF.

Thread	Dimensions (mm/in)								Order Codes
	inch	Ø d1	Ø d2	l1	l2	l3	l4	Hex A	
7/16-20 UNF	7,49	4,9	9	14	37	8	27	17	SGV-7/16UNF-04-JIC1/4-F/M-C6F
	.29	.19	.35	.55	1.46	.31	1.06	.67	
9/16-18 UNF	11,05	8,1	10,5	14	37,5	8,5	27	19	SGV-7/16UNF-06-JIC3/8-F/M-C6F
	.44	.32	.41	.55	1.48	.33	1.06	.75	
3/4-16 UNF	15,9	10,8	10,5	16,7	43,7	12	30	22	SGV-7/16UNF-08-JIC1/2-F/M-C6F
	.63	.43	.41	.66	1.72	.47	1.18	.87	
1-1/16-12 UN	21,6	16,9	15,4	21,9	50,4	13,5	36	32	SGV-7/16UNF-12-JIC3/4-F/M-C6F
	.85	.66	.61	.86	1.98	.53	1.42	1.26	
1-5/16-12 UN	27,9	23,2	17,3	23,1	53,1	15	41	41	SGV-7/16UNF-16-JIC1-F/M-C6F
	1.10	.91	.68	.91	2.09	.59	1.61	1.61	

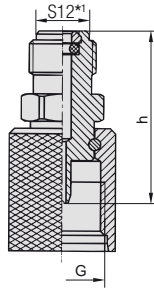
**Adaptor
SAD12**

Version A

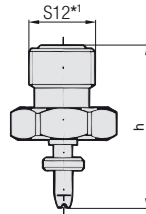

Version B



Thread	Dimensions (mm/in)	Version	Order Codes	
			NBR	FPM* (Standard Option-North America)
	G	h		
M16 x 2	33 1.30	A	SAD12/20-P-C6F	SAD12/20-V-C6F
M16 x 1,5	33 1.30	A	SAD12/15-P-C6F	SAD12/15-V-C6F
Plug in	31 1.22	B	SAD12/10-P-C6F	SAD12/10-V-C6F

Threads

*1 Special thread: buttress thread S12,65 x1,5

Metal Parts

Standard material: Steel, zinc/nickel-plated = **C6F (CrVI-free)**
 For ordering V2A (1.4305 / AISI 303) replace "C6F" with "V2A".
 For ordering V4A (1.4571 / AISI 316Ti) replace "C6F" with "V4A".

Sealings

For ordering FPM sealings replace "P" with "V".
 For ordering EPDM sealings replace "P" with "E".

* Standard option for North America is FPM (Viton®).

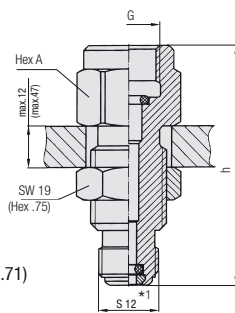

Through
hole Ø 18 (.71)

Gauge Adaptor SMA12

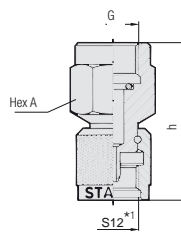

Direct Gauge Adaptor SMD12

**Gauge Adaptor
SMA12**
**Direct Gauge Adaptor
SMD12**

Thread	Dimensions (mm/in)		Order Codes	
	G	Hex A	NBR	FPM* (Standard Option-North America)
G1/4	51 2.01	19 .75	SMA12-G1/4-P-OR-C6F	SMA12-G1/4-V-OR-C6F
G1/2	61 2.40	27 1.06	SMA12-G1/2-P-OR-C6F	SMA12-G1/2-V-OR-C6F
1/4 NPT	51 2.01	19 .75	SMA12-1/4NPT-P-C6F	SMA12-1/4NPT-V-C6F
1/2 NPT	61 2.40	27 1.06	SMA12-1/2NPT-P-C6F	SMA12-1/2NPT-V-C6F
G1/4	35 1.38	19 .75	SMD12-G1/4-P-OR-C6F	SMD12-G1/4-V-OR-C6F
G1/2	45 1.77	27 1.06	SMD12-G1/2-P-OR-C6F	SMD12-G1/2-V-OR-C6F
1/4 NPT	35 1.38	19 .75	SMD12-1/4NPT-C6F	
1/2 NPT	45 1.77	27 1.06	SMD12-1/2NPT-C6F	

Threads

*1 Special thread: buttress thread S12,65 x1,5

Metal Parts

Standard material: Steel, zinc/nickel-plated = **C6F (CrVI-free)**
 For ordering V2A (1.4305 / AISI 303) replace "C6F" with "V2A".
 For ordering V4A (1.4571 / AISI 316Ti) replace "C6F" with "V4A".

Sealings

For ordering FPM sealings replace "P" with "V".
 For ordering EPDM sealings replace "P" with "E".

* Standard option for North America is FPM (Viton®).

Snubber on request.

Test Coupling with Ball Check

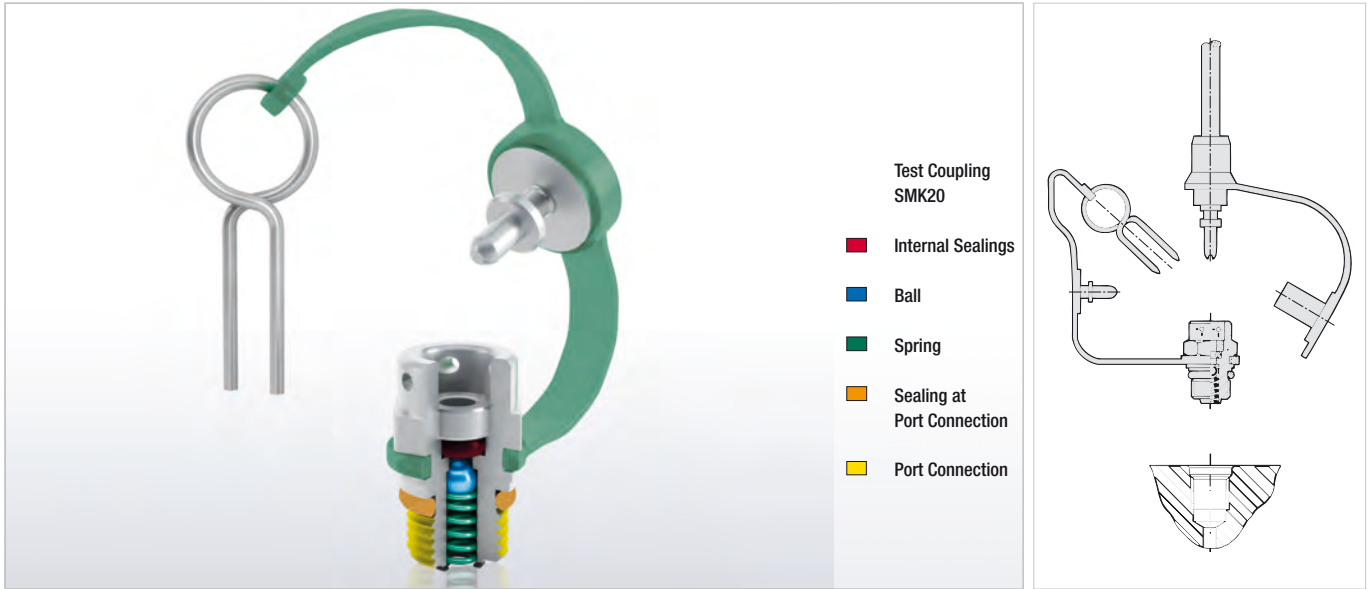

Fast coupling for

- Monitoring and control of pressure
- Venting
- Sampling in high- and low-pressure systems

Advantages

- Test system at working pressure
- Leak proof connection before **ball check** is open
- Simple connection to measurement, control and switching devices

Working Pressure

- Max. working pressure 400 bar / 5801 PSI
For SMK Type G and K the recommended working pressure of fitting manufacturer should be noted.

Materials

- **Metal Parts:**
Standard material: Steel, zinc/nickel-plated = **C6F (CrVI-free)**
- **Ball:** Stainless Steel

Sealings:

P = NBR (Buna-N®)

(Temperature range -20 °C ... +100 °C / -4 °F ... +212 °F)

Note: Internal sealings made of FPM, even for standard NBR-type.

V = FPM (Viton®)*

(Temperature range -20 °C ... +200 °C / -4 °F ... +392 °F)

*** Standard option for North America is FPM (Viton®)**

E = EPDM Ethylene Propylene Diene Monomer Rubber

(for Brake fluid,

Temperature range -40 °C ... +150 °C / -40 °F ... +302 °F)

For ordering FPM or EPDM sealings please replace "P" with "V" or "E".

Media

- Suitable for hydraulic oils and other Mineral oil based fluids (Check compatibility of seal material)
- For use with other liquid media please consult STAUFF

SMK10
Test Coupling
with Port Connection



SMK10 Type G
Test Coupling complete
with Straight Fitting



SMK10 Type K
Test Coupling for
24° Cone Fittings



Test Coupling with Port Connection SMK10

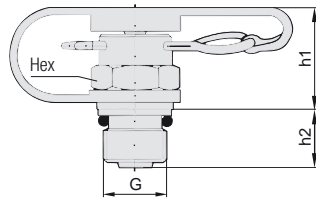

Thread	Sealing	Working Pressure (bar / psi)	Dimensions (mm / in)			Order Codes	
			h1	h2	Hex	NBR	FPM* (Standard Option-North America)
M8 x 1	Type A	250	17,5	8,5	12	SMK10-M8x1-PA-C6F	SMK10-M8x1-VA-C6F
		3625	.69	.33	.47		
M10 x 1		400	17,5	9,8	12	SMK10-M10x1-PA-C6F	SMK10-M10x1-VA-C6F
		5801	.69	.39	.47		
R1/8 K	Type D	400	17,5	8	12	SMK10-R1/8K-PD-C6F	SMK10-R1/8K-VD-C6F
		5801	.69	.31	.47		

For further information on materials or seals, please see page B28.
Further thread versions possible with use of thread adaptors SRS20, please see page B32.

Metal Parts

Standard material: Steel, zinc/nickel-plated = C6F (CrVI-free)

Sealings

For ordering FPM sealings replace "P" with "V".
For ordering EPDM sealings replace "P" with "E".

* Standard option for North America is FPM (Viton®).

Sealing Details



O-ring Type A



Taper Type D
(suitable sealant required)

Gauge Adaptor SMA10

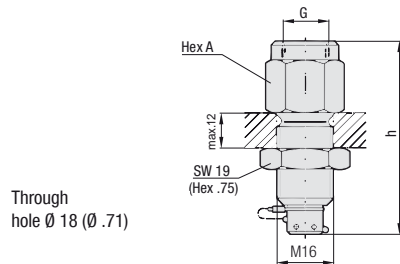

Thread	Dimensions (mm / in)		Order Codes	
	h	Hex A	NBR	FPM* (Standard Option-North America)
G1/4	57	19	SMA10-G1/4-P-OR-C6F	SMA10-G1/4-V-OR-C6F
	2.24	.75		
G1/2	67	27	SMA10-G1/2-P-OR-C6F	SMA10-G1/2-V-OR-C6F
	2.64	1.06		
1/4 NPT	57	19	SMA10-1/4NPT-P-C6F	SMA10-1/4NPT-V-C6F
	2.24	.75		
1/2 NPT	67	27	SMA10-1/2NPT-P-C6F	SMA10-1/2NPT-V-C6F
	2.64	1.06		

Metal Parts

Standard material: Steel, zinc/nickel-plated = C6F (CrVI-free)

Sealings

For ordering FPM sealings replace "P" with "V".
For ordering EPDM sealings replace "P" with "E".

* Standard option for North America is FPM (Viton®).

Snubber on request.

**Test Coupling complete with Straight Fitting
SMK10 Type G**

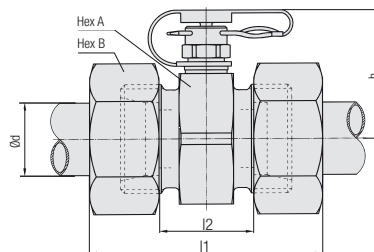

▪ Compression ring fittings acc. to ISO 8434-1 / DIN 2353

Metal Parts

Standard material: Steel, zinc/nickel-plated = **C6F (CrVI-free)**

Sealings

For ordering FPM sealings replace "P" with "V".
For ordering EPDM sealings replace "P" with "E".

* **Standard option for North America is FPM (Viton®).**

For further information on materials or sealings, please see page B28.

Series	PN (^{bar} /PSI)	Pipe Ød	Dimensions (mm /in)					Order Codes	
			~l1	l2	h	Hex A	Hex B	NBR	FPM* (Standard Option-North America)
L	315 4568	6	51	21	29,5	24	14	SMK10-06L-PG-C6F	SMK10-06L-VG-C6F
			2.01	.83	1.16	.94	.55		
		8	51	21	29,5	24	17	SMK10-08L-PG-C6F	SMK10-08L-VG-C6F
			2.01	.83	1.16	.94	.67		
		10	53	23	29,5	24	19	SMK10-10L-PG-C6F	SMK10-10L-VG-C6F
			2.09	.91	1.16	.94	.75		
	12	53	23	31	27	22	SMK10-12L-PG-C6F	SMK10-12L-VG-C6F	
		2.09	.91	1.22	1.06	.87			
	15	55	25	32,5	30	27	SMK10-15L-PG-C6F	SMK10-15L-VG-C6F	
		2.17	.98	1.28	1.18	1.06			
	18	57	24	33,5	32	32	SMK10-18L-PG-C6F	SMK10-18L-VG-C6F	
		2.24	.94	1.32	1.26	1.26			
	160 2320	22	61	28	33,5	36	36	SMK10-22L-PG-C6F	SMK10-22L-VG-C6F
			2.40	1.10	1.32	1.42	1.42		
28		61	28	38	41	41	SMK10-28L-PG-C6F	SMK10-28L-VG-C6F	
		2.40	1.10	1.50	1.61	1.61			
35		69	26	40,5	46	50	SMK10-35L-PG-C6F	SMK10-35L-VG-C6F	
	2.72	1.02	1.59	1.81	1.97				
42	71	25	45	55	60	SMK10-42L-PG-C6F	SMK10-42L-VG-C6F		
S	400 5801	6	55	25	29,5	24	17	SMK10-06S-PG-C6F	SMK10-06S-VG-C6F
			2.17	.98	1.16	.94	.67		
		8	55	25	29,5	24	19	SMK10-08S-PG-C6F	SMK10-08S-VG-C6F
			2.17	.98	1.16	.94	.75		
		10	57	24	29,5	24	22	SMK10-10S-PG-C6F	SMK10-10S-VG-C6F
			2.24	.94	1.16	.94	.87		
		12	57	24	29,5	24	24	SMK10-12S-PG-C6F	SMK10-12S-VG-C6F
			2.24	.94	1.16	.94	.94		
		14	63	27	31	27	27	SMK10-14S-PG-C6F	SMK10-14S-VG-C6F
			2.50	1.06	1.22	1.06	1.06		
		16	63	26	32,5	30	30	SMK10-16S-PG-C6F	SMK10-16S-VG-C6F
			2.50	1.02	1.28	1.18	1.18		
		20	69	26	35,5	36	36	SMK10-20S-PG-C6F	SMK10-20S-VG-C6F
			2.72	1.02	1.40	1.42	1.42		
25	75	27	38	41	46	SMK10-25S-PG-C6F	SMK10-25S-VG-C6F		
	2.95	1.06	1.50	1.61	1.81				
30	81	28	40,5	46	50	SMK10-30S-PG-C6F	SMK10-30S-VG-C6F		
	3.19	1.10	1.59	1.81	1.97				
315 4568	38	91	29	45	55	60	SMK10-38S-PG-C6F	SMK10-38S-VG-C6F	
			3.58	1.14	1.77	2.17	2.36		

Test Coupling for 24° Cone Fittings SMK10 Type K

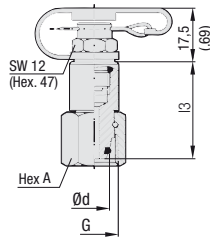

Version A

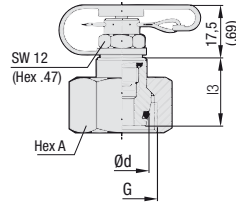

Version B



Series	PN (^{bar} /PSI)	Pipe Ød	Dimensions (mm/in)			Thread	Version	Order Codes	
			I3	Hex A	G			NBR	FPM* (Standard Option-North America)
L	315 4568	6	15,5 .61	14 .55		M12 x 1,5	A	SMK10-06L-PK-GS-C6F	SMK10-06L-VK-GS-C6F
		8	15,5 .61	17 .67		M14 x 1,5	A	SMK10-08L-PK-GS-C6F	SMK10-08L-VK-GS-C6F
		10	16,5 .65	19 .75		M16 x 1,5	A	SMK10-10L-PK-GS-C6F	SMK10-10L-VK-GS-C6F
		12	17,5 .69	22 .87		M18 x 1,5	A	SMK10-12L-PK-GS-C6F	SMK10-12L-VK-GS-C6F
		15	21 .83	27 1.06		M22 x 1,5	B	SMK10-15L-PK-GS-C6F	SMK10-15L-VK-GS-C6F
		18	19,5 .77	32 1.26		M26 x 1,5	B	SMK10-18L-PK-GS-C6F	SMK10-18L-VK-GS-C6F
	160 2320	22	20,5 .81	36 1.42		M30 x 2	B	SMK10-22L-PK-GS-C6F	SMK10-22L-VK-GS-C6F
		28	25 .98	41 1.61		M36 x 2	B	SMK10-28L-PK-GS-C6F	SMK10-28L-VK-GS-C6F
		35	30 1.18	50 1.97		M45 x 2	B	SMK10-35L-PK-GS-C6F	SMK10-35L-VK-GS-C6F
		42	31 1.22	60 2.36		M52 x 2	B	SMK10-42L-PK-GS-C6F	SMK10-42L-VK-GS-C6F
S	400 5801	6	14,5 .57	17 .67		M14 x 1,5	A	SMK10-06S-PK-GS-C6F	SMK10-06S-VK-GS-C6F
		8	16,5 .65	19 .75		M16 x 1,5	A	SMK10-08S-PK-GS-C6F	SMK10-08S-VK-GS-C6F
		10	16,5 .65	22 .87		M18 x 1,5	A	SMK10-10S-PK-GS-C6F	SMK10-10S-VK-GS-C6F
		12	17,5 .69	24 .94		M20 x 1,5	A	SMK10-12S-PK-GS-C6F	SMK10-12S-VK-GS-C6F
		14	19,5 .77	27 1.06		M22 x 1,5	B	SMK10-14S-PK-GS-C6F	SMK10-14S-VK-GS-C6F
		16	18 .71	30 1.18		M24 x 1,5	B	SMK10-16S-PK-GS-C6F	SMK10-16S-VK-GS-C6F
		20	24 .94	36 1.42		M30 x 2	B	SMK10-20S-PK-GS-C6F	SMK10-20S-VK-GS-C6F
		25	26 1.02	46 1.81		M36 x 2	B	SMK10-25S-PK-GS-C6F	SMK10-25S-VK-GS-C6F
	315 4568	30	30 1.18	50 1.97		M42 x 2	B	SMK10-30S-PK-GS-C6F	SMK10-30S-VK-GS-C6F
		38	34 1.34	60 2.36		M52 x 2	B	SMK10-38S-PK-GS-C6F	SMK10-38S-VK-GS-C6F

- For DKO connection
- According to ISO 8434-1 / DIN 2353

Metal Parts

Standard material: Steel, zinc/nickel-plated = C6F (CrVI-free)

Sealings

For ordering FPM sealings replace "P" with "V".
For ordering EPDM sealings replace "P" with "E".

* Standard option for North America is FPM (Viton®).

For further information on materials or sealings, please see page B28.

Thread Adaptor SRS20

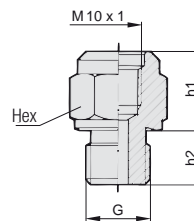

Metal Parts

Standard Material SRS20:

Steel, zinc/nickel-plated = **C6F (CrVI-free)**

For ordering V2A (1.4305 / AISI 303) replace "C6F" with "V2A".

For ordering V4A (1.4571 / AISI 316Ti) replace "C6F" with "V4A".

Sealings

For ordering FPM sealings replace "P" with "V".

For ordering EPDM sealings replace "P" with "E".

* Standard option for North America is FPM (Viton®).

Sealing Details



Metal Joint Type B



Elastomeric Sealing Type C



Taper Type D
(suitable sealant required)



O-ring Type E

Thread	Sealing	Dimensions (mm/in)			Order Codes
		h1	h2	Hex	
M10 x 1		15,5	8,5	17	SRS20-M10x1-B-C6F
		.61	.33	.67	
M12 x 1,5		15	12	19	SRS20-M12x1,5-B-C6F
		.59	.47	.75	
M14 x 1,5		15	12	19	SRS20-M14x1,5-B-C6F
		.59	.47	.75	
M16 x 1,5		8	12	22	SRS20-M16x1,5-B-C6F
		.31	.47	.87	
M18 x 1,5	Type B	15	12	24	SRS20-M18x1,5-B-C6F
		.59	.47	.94	
M22 x 1,5		10,5	14	27	SRS20-M22x1,5-B-C6F
		.41	.55	1.06	
G1/8		15,5	8	17	SRS20-G1/8-B-C6F
		.61	.31	.67	
G1/4		15	12	19	SRS20-G1/4-B-C6F
		.59	.47	.75	
G3/8		10,5	12	22	SRS20-G3/8-B-C6F
		.41	.47	.87	
G1/2		10,5	14	27	SRS20-G1/2-B-C6F
		.41	.55	1.06	
M12 x 1,5		15	12	19	SRS20-M12x1,5-PC-C6F
		.59	.47	.75	
M14 x 1,5		15	12	19	SRS20-M14x1,5-PC-C6F
		.59	.47	.75	
M18 x 1,5		15	12	24	SRS20-M18x1,5-PC-C6F
		.59	.47	.94	
G1/8	Type C	16	8	17	SRS20-G1/8-PC-C6F
		.63	.31	.67	
G1/4		15	12	19	SRS20-G1/4-PC-C6F
		.59	.47	.75	
G3/8		10,5	12	22	SRS20-G3/8-PC-C6F
		.41	.47	.87	
G1/2		10,5	14	27	SRS20-G1/2-PC-C6F
		.41	.55	1.06	
R1/4 K		13	12	17	SRS20-R1/4K-D-C6F
		.51	.47	.67	
R3/8 K		13	14	19	SRS20-R3/8K-D-C6F
		.51	.55	.75	
R1/2 K	Type D	8	19	22	SRS20-R1/2K-D-C6F
		.31	.75	.87	
1/4 NPT		10	15	17	SRS20-1/4NPT-D-C6F
		.39	.59	.67	
1/2 NPT		8	20	22	SRS20-1/2NPT-D-C6F
		.31	.79	.87	
7/16-20 UNF		9	9,1	17	SRS20-7/16UNF-PE-C6F
		.35	.36	.67	
1/2-20 UNF		15	9,2	17	SRS20-1/2UNF-PE-C6F
		.59	.36	.67	
9/16-18 UNF		15,5	10	19	SRS20-9/16UNF-PE-C6F
		.61	.39	.75	
7/8-14 UNF		11	16	27	SRS20-7/8UNF-PE-C6F
		.43	.63	1.06	
M14 x 1,5	Type E	14,5	11	19	SRS20-M14x1,5-PE-C6F
		.57	.43	.75	
M16 x 1,5		8,5	12,5	22	SRS20-M16x1,5-PE-C6F
		.33	.49	.87	
M22 x 1,5		10	15	27	SRS20-M22x1,5-PE-C6F
		.39	.59	1.06	
M27 x 2		10	18,5	32	SRS20-M27x2-PE-C6F
		.39	.73	1.26	

Thread Adaptor SRS15

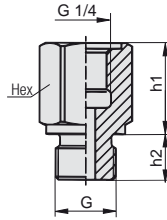

Thread	Sealing	Dimensions (mm/in)			Order Codes
		h1	h2	Hex	
G					
M14 x 1,5	Type B	24	12	19	SRS15-M14x1,5-B-C6F
		.95	.47	.75	
M16 x 1,5		24	12	22	SRS15-M16x1,5-B-C6F
		.95	.47	.87	
M18 x 1,5		24	12	24	SRS15-M18x1,5-B-C6F
		.95	.47	.95	
M20 x 1,5		10,5	14	27	SRS15-M20x1,5-B-C6F
		.41	.55	1.06	
G3/8		24	12	22	SRS15-G3/8-B-C6F
		.95	.47	.87	
G1/2	10,5	14	27	SRS15-G1/2-B-C6F	
	.41	.55	1.06		
M14 x 1,5	Type C	24	12	19	SRS15-M14x1,5-PC-C6F
		.95	.47	.75	
M16 x 1,5		24	12	22	SRS15-M16x1,5-PC-C6F
		.95	.47	.87	
M18 x 1,5		24	12	24	SRS15-M18x1,5-PC-C6F
		.95	.47	.95	
G3/8		24	12	22	SRS15-G3/8-PC-C6F
			.95	.47	

Metal Parts

Standard material SRS15:

Steel, zinc/nickel-plated = **C6F (CrVI-free)**

For ordering V2A (1.4305 / AISI 303) replace "C6F" with "V2A".

For ordering V4A (1.4571 / AISI 316Ti) replace "C6F" with "V4A".

Sealings

For ordering FPM sealings replace "P" with "V".

For ordering EPDM sealings replace "P" with "E".

* Standard option for North America is FPM (Viton®).

Sealing Details



Metal Joint Type B



Elastomeric Sealing Type C

Welding Adaptor SAS

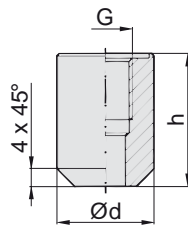

Thread	Port Connection	Dimensions (mm/in)		Order Codes
		h	Ød	
G				
M10 x 1	Type A	25	20	SAS-M10x1
		.98	.79	
G1/8	Type B/C	25	20	SAS-G1/8
		.98	.79	
G1/4		30	22	SAS-G1/4
		1.18	.87	
G3/8		30	25	SAS-G3/8
		1.18	.98	
1/4 NPT	Type D	25	20	SAS-1/4NPT
		.98	.79	
1/2-20 UNF	Type E	25	20	SAS-1/2UNF
		.98	.79	

Metal Parts

Standard material: **S235 (St 37), phosphated**

Pressure Gauge SPG

Further information on these products please see Diagtronics section on:

- Page D6 / D7 for Pressure Gauge (analogue) SPG
- Page D10 for Pressure Gauge (digital) SPG-DIGI

Further information on these products please see STAUFF Test section on:

- Page B11, B21, B27 and B29 for Gauge Adaptor SMA
- Page B11, B27 and B27 for Direct Gauge Adaptor SMD
- Page B36 for Test Hose - Gauge Adaptor
- Page B34 for Adjustable Gauge Fitting EMV

Further information on these products please see Valve section on:

- Page F90 for Single Station Gauge Isolater Valve
- Page F90 for Multi Station Gauge Isolater Valve
- Page F91 for Gauge Isolater Valve Needle Valve



Adjustable Gauge Fitting EMV

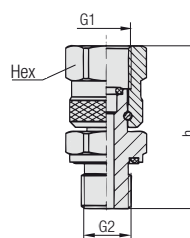

Metal Parts

Standard material: Steel, zinc/nickel-plated = **C6F (CrVI-free)**
 For ordering V2A (1.4305 / AISI 303) replace "C6F" with "V2A".
 For ordering V4A (1.4571 / AISI 316Ti) replace "C6F" with "V4A".

Sealings

For ordering FPM sealings replace "P" with "V".
 For ordering EPDM sealings replace "P" with "E".

* Standard option for North America is FPM (Viton®).

Dimensions (mm/in)				Order Codes	FPM* (Standard Option-North America)
G1	G2	h	Hex	NBR	
G1/4	G1/4	42	19	EMV-G1/4-P-OR-PC-C6F	EMV-G1/4-V-OR-VC-C6F
		1.65	.75		
G1/4	G1/2	47	19	EMV-G1/4G1/2-P-OR-PC-C6F	EMV-G1/4G1/2-V-OR-VC-C6F
		1.85	.75		
G1/2	G1/4	51	27	EMV-G1/2G1/4-P-OR-PC-C6F	EMV-G1/2G1/4-V-OR-VC-C6F
		2.01	1.06		
G1/2	G1/2	55,5	27	EMV-G1/2-P-OR-PC-C6F	EMV-G1/2-V-OR-VC-C6F
		2.19	1.06		

Pressure Test Kit SMB



SMB20-1-xxx/xxx-C6F or SMB15-1-xxx/xxx-C6F



SMB20-2-xxx/xxx-C6F or SMB15-2-xxx/xxx-C6F



SMB20-3-xxx/xxx-C6F or SMB15-3-xxx/xxx-C6F



SMB20/100-1-xxx-C6F or SMB15/100-1-xxx-C6F



SMB-DIGI

In addition to the individual SPG gauges, the STAUFF Pressure Gauges are also available as a part of a Pressure Test Kit SMB.

The SMB Pressure Test Kits are assembled in various versions, in accordance with customer wishes.

All Pressure Test Kits are supplied in a handy case with custom-designed foam inserts.

Further information on these products and components please see Diagtronics section on:

- Page D8 / D9 for Pressure Test Kit (analogue) SMB20

Note: All test kits are available as SMB15 version.

Pressure Test Kit (Digital) SMB-DIGI

In addition to the individual SPG-DIGI devices, the STAUFF Digital Pressure Gauges are also available as a part of a Pressure Test Kit SMB-DIGI.

The SMB-DIGI Pressure Test Kits are assembled in various versions, in accordance with customer wishes.

All Pressure Test Kits are supplied in a handy case with custom-designed foam inserts.

Further information on these products and components please see Diagtronics section on:

- Page D11 for Pressure Test Kit (digital) SMB-DIGI

Technical Data for Test Hose



		A	B	C	D
Nominal Bore (DN)	(mm)	DN 2		DN 4	
Max. Working Pressure (PN)	(bar / PSI)	400 / 5801	630 / 9135	340 / 4931	630 / 9135
Min. Burst Pressure	(bar / PSI)	1100 / 15954	1900 / 27557	850 / 12328	1900 / 27557
Testing Pressure	(bar / PSI)	600 / 8702	950 / 13778	570 / 8267	950 / 13779
Pressure Rating in bar / PSI at Indicated Temperature	at 0 °C / 32 °F (122 %)	488 / 7077	768 / 11139	415 / 6016	768 / 11139
	at 30 °C / 86 °F (110 %)	440 / 6381	693 / 10051	374 / 5424	693 / 10051
	at 50 °C / 122 °F (100 %)	400 / 5801	630 / 9137	340 / 4931	630 / 9137
	at 80 °C / 176 °F (86 %)	344 / 4989	542 / 7861	292 / 4241	542 / 7861
	at 100 °C / 212 °F (77 %)	308 / 4467	485 / 7034	262 / 3797	485 / 7034
Working Temperature	(°C / °F)	-35 °C ... +100 °C / -31 °F ... +212 °F (momentary +120 °C / +248 °F)			
Inside Diameter	(mm / in)	2 / .08		4 / .16	
Outside Diameter	(mm / in)	5 / .20		8,6 / .34	
Bending Radius	at working pressure	20 / .79		40 / 1.57	
	at -20 °C / 4 °F	30 / 1.18		60 / 2.36	
Max. Coil Length	(m / ft)	100 / 328			
Weight / m	(g / oz)	16 / .50		42 / 1.35	
Inner / Outer Tube		PA			
Reinforcement		Synthetic Fibre			
Standard hose end material is Steel 11 S Mn Pb 30 (1.0718), zinc/ nickel-plated (Type 15: Steel, black zinc/nickel-plated)					
Stainless Steel: V2A (1.4305/AISI 303), V4A (1.4571/AISI 316Ti) on request					

STAUFF Test Hoses (Selection)

STAUFF-Test 20/20

STAUFF-Test 15/15

STAUFF-Test 12/12*2

STAUFF-Test 10/10

Gauge Adaptor



*2 Special thread: buttress thread S12,65 x 1,5



Order Code STAUFF Test Hose

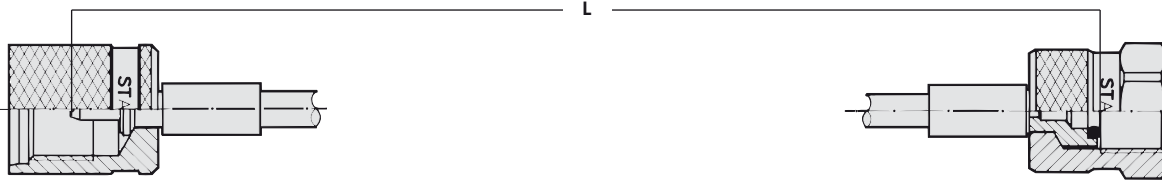

SMS *1	20	/ M	3000	A	C6F
--------	----	-------------	------	---	-----

Hose End 1 (see pages B38 - B43)	Hose End 2 (see pages B38 - B43)		Length	DN / Hose Size	Material Hose End
20 A J	only specify when 2 different hose ends are required		Length in mm (see L above)	A = DN 2 400 bar / 5802 PSI	Standard hose end material is Steel 11 S Mn Pb 30 (1.0718), zinc/nickel-plated = C6F Type 15: Steel, black zinc/nickel-plated = C6F Stainless Steel: V2A (1.4305/AISI 303), V4A (1.4571/AISI 316Ti) on request
15 S D				B*2 = DN 2 630 bar / 9137 PSI	
12 K B			Standard Lengths see table below.	C*3 = DN 4 340 bar / 4931 PSI	
10 L U				D*3 = DN 4 630 bar / 9137 PSI	
M G P					
N F etc.					
W C					

*1 for gaseous media type SGS - Test hoses are perforated
 *2 Standard test hose option for North America is version B.
 *3 Type C and D - are perforated

Standard Length L*	
in mm	in in
200	7.87
400	15.75
630	24.80
800	31.50
1000	39.37
1500	59.06
2000	78.74
2500	98.43
3200	125.98
4000	157.48

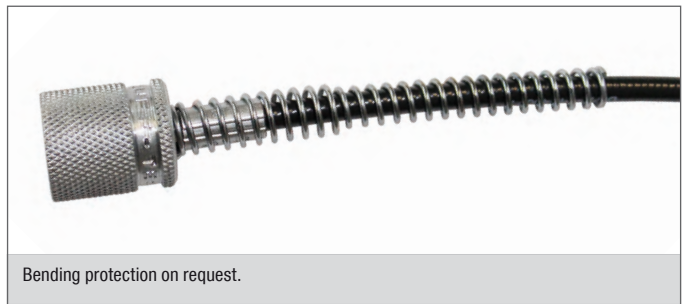
 STAUFF
Test
B

Order Code STAUFF Hose End

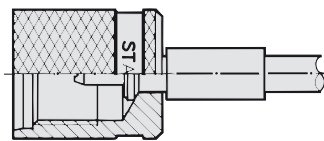

HE	20	A	C6F
----	----	---	-----

Hose End (see pages B38 - B43)			DN / Hose Size	Material Hose End
20 A J			A = DN 2	Standard hose end material is Steel 11 S Mn Pb 30 (1.0718), zinc/nickel-plated = C6F Type 15: Steel, black zinc/nickel-plated = C6F Stainless Steel: V2A (1.4305/AISI 303), V4A (1.4571/AISI 316Ti) on request
15 S D			C = DN 4	
12 K B				
10 L U				
M G P				
N F etc.				
W C				

STAUFF Hose End

Hose End	Description	Type	G	Hex (mm/in)	DN Hose Size	
	STAUFF-Test Screw-type suitable for test points		20	M16 x 2	2 and 4	
			15	M16 x 1,5		
			12	S12,65 x 1,5		
	STAUFF-Test Screw-type 90° elbow suitable for test points	0	20	M16 x 2	2	
			15	M16 x 1,5		
			12	S12,65 x 1,5		
	STAUFF-Test Screw-type 90° elbow suitable for test points (short wire version)	OX	20	M16 x 2	17 .67 2	
			15	M16 x 1,5		
			12	S12,65 x 1,5		
	STAUFF-Test Plug in-type		10	Plug in system	2	
	Gauge adaptor BSP-thread for G3/8, G1/2, M14 x 1,5 and M20 x 1,5 swivel nut like type N	M	1/4	G1/4	19 .75	2 and 4
			1/2	G1/2	27 1.06	
			3/8	G3/8	22 .87	2
			14	M14 x 1,5	19 .75	
			20	M20 x 1,5	27 1.06	

STAUFF Hose End

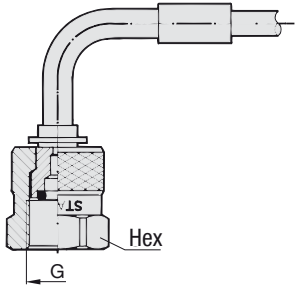
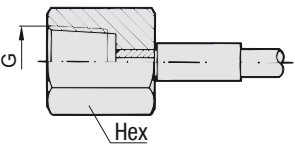
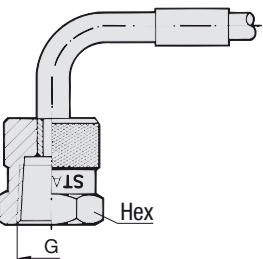
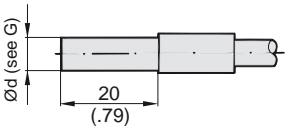
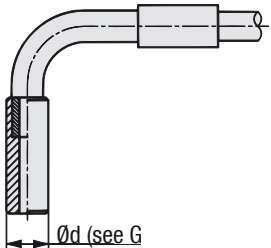
Hose End	Description	Type	G	Hex (mm/in)	DN Hose Size	
	90° elbow gauge adaptor BSP-thread for G1/2 swivel nut like type N	W	1/4	G1/4	19 .75	2 and 4
			1/2	G1/2	27 1.06	
	Gauge adaptor NPT-thread for 1/4 NPT swivel nut like type M	N	1/4	1/4 NPT	19 .75	2
			1/2	1/2 NPT	27 1.06	
	90° elbow gauge adaptor NPT-thread for 1/2 NPT swivel nut like type N	A	1/4	1/4 NPT	19 .75	2 and 4
			1/2	1/2 NPT	27 1.06	
	Standpipe for compression ring fittings according to ISO 8434-1 / DIN 2353 Note: Standpipe version is not in accordance with the state of the art. Use at own risk. We recommend the use of the series K, R or L.	S	4	4 LL		2
			6	6 L - 6 S		2 and 4
			8	8 L - 8 S		
			10	10 L - 10 S		2
			12	12 L - 12 S		2
	Standpipe for compression ring fittings according to ISO 8434-1 / DIN 2353 90° elbow Note: Standpipe version is not in accordance with the state of the art. Use at own risk. We recommend the use of the series K, R or L.	SG	6	6 L - 6 S		2 and 4
			8	8 L - 8 S		

STAUFF Hose End

Hose End	Description	Type	G	Hex (mm/in)	DN Hose Size	
	Seal with O-ring for 24° cone fitting according to ISO 8434-1 / DIN 2353 c/w swivel nut	K	6 L	M12 x 1,5	14 .55	2 and 4
			8 L	M14 x 1,5	17 .67	
			10 L	M16 x 1,5	19 .75	
			12 L	M18 x 1,5	22 .87	
			6 S	M14 x 1,5	17 .67	
			8 S	M16 x 1,5	19 .75	
			10 S	M18 x 1,5	22 .87	
			12 S	M20 x 1,5	24 .94	
	Seal with O-ring for 24° cone fitting according to ISO 8434-1 / DIN 2353 c/w swivel nut 45° elbow	R	6 L	M12 x 1,5	14 .55	2 and 4
			6 S	M14 x 1,5	14 .67	
	Seal with O-ring for 24° cone fitting according to ISO 8434-1 / DIN 2353 c/w swivel nut 90° elbow	L	6 L	M12 x 1,5	14 .55	2 and 4
			8 L	M14 x 1,5	17 .67	
			10 L	M16 x 1,5	19 .75	
			6 S	M14 x 1,5	17 .67	
			8 S	M16 x 1,5	19 .75	
			10 S	M18 x 1,5	24 .94	
	Male thread according to DIN 3852-B	G	12	M12 x 1,5	17 .67	2 and 4
			1/8	G1/8	14 .55	
			1/4	G1/4	19 .75	
			1/2	G1/2	27 1.06	
	Male thread NPT according to ANSI-standard	F	1/8	1/8 NPT	13 .51	2 and 4
			1/4	1/4 NPT	17 .67	

STAUFF Hose End

Hose End	Description	Type	G	Hex (mm/in)		DN Hose Size	
	Male thread for 24° cone fitting according to ISO 8434-1 / DIN 2353	C	6 L	M12 x 1,5	14	.55	2 and 4
			8 L	M14 x 1,5	17	.67	
			6 S	M14 x 1,5	17	.67	
			8 S	M16 x 1,5	17	.67	
	Male thread according to SAE J 514	J	1/4	7/16-20 UNF	14	.55	2 and 4
			5/16	1/2-20 UNF	14	.55	
			3/8	9/16-18 UNF	17	.67	
	Universal sealing head with swivel nut for 24° cone fitting according to ISO 8434-1 / DIN 2353	D	6 L	M12 x 1,5	14	.55	2 and 4
			8 L	M14 x 1,5	17	.67	
			10 L	M16 x 1,5	19	.75	
			12 L	M18 x 1,5	22	.87	
			6 S	M14 x 1,5	17	.67	
			8 S	M16 x 1,5	19	.75	
			10 S	M18 x 1,5	22	.87	
	Universal sealing head with swivel nut for 24° cone fitting according to ISO 8434-1 / DIN 2353 90° elbow	Q	10 L	M16 x 1,5	19	.75	2 and 4
			10 S	M18 x 1,5	22	.87	
	Sealing head with swivel nut for cone fitting according to DIN EN 560	B	1/8	G1/8	12	.47	2
			1/4	G1/4	17	.67	2 and 4

STAUFF Hose End

Hose End	Description	Type	G	Hex (mm/in)		DN Hose Size	
	Sealing head with swivel nut according to SAE J 514 37° cone	U	1/4	7/16-20 UNF	14	.55	2 and 4
			5/16	1/2-20 UNF	17	.67	
			3/8	9/16-18 UNF	19	.75	
	Sealing head with swivel nut according to SAE J 516 45° cone	UR	1/4	7/16-20 UNF	14	.55	2
	Sealing head with swivel nut according to SAE J 516 37° cone 90° elbow	E	1/4	7/16-20 UNF	14	.55	2 and 4
	Sealing head with swivel nut according to SAE J 516 45° cone 90° elbow	ER	1/4	7/16-20 UNF	14	.55	2
	Test hose for air brake systems	P	2	M16 x 1,5	19	.75	2

STAUFF Hose End

Hose End	Description	Type		G	Hex (mm/in)		DN Hose Size
	Sealing head with swivel nut 60° cone	H	1/4	G1/4	17	.67	2 and 4
	Screw-type ORFS according to SAE J 1453	T	9/16	9/16-18 UNF	17	.67	2
			11/16	11/16-16 UN	21	.83	
	Screw-type ORFS according to SAE J 1453 90° elbow	V	11/16	11/16-16 UN	21	.83	2 and 4
	Hose end with integrated check valve	RV	20	M16 x 2			2
			15	M16 x 1,5			

**Hose Connector
SSV**

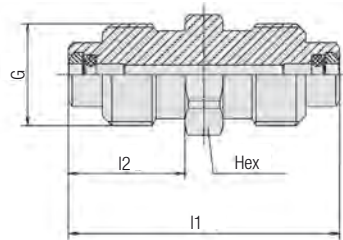

Sealings

Internal sealings made of FPM (Viton®).

Metal Parts

Standard material: Steel, zinc/nickel-plated = **C6F (CrVI-free)**

Standard material SSV15:

Steel, black zinc/nickel-plated = **C6F (CrVI-free)**

For ordering **V2A (1.4305 / AISI 303)** replace "C6F" with "V2A".

For ordering **V4A (1.4571 / AISI 316Ti)** replace "C6F" with "V4A".

Thread	Dimensions (mm/in)			Order Codes
	l1	l2	Hex	
M16 x 2	42,5	18,5	17	SSV20-C6F
	1.67	.73	.67	
M16 x 1,5	42,5	18,5	17	SSV15-C6F
	1.67	.73	.67	
S12,65 x 1,5	31	12,5	14	SSV12-C6F
	1.22	.49	.55	

**Sampling Hose Adaptor
SHA**

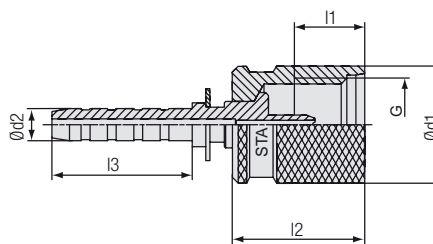

Metal Parts

Standard material: Steel, zinc/nickel-plated = **C6F (CrVI-free)**

Dimensions (mm/in)	Order Code					
	Ød1	Ød2	l1	l2	l3	G
22	5,5	13	23	24	18	SHA20-5,5MM-C6F
.87	.22	.51	.91	.94	.71	

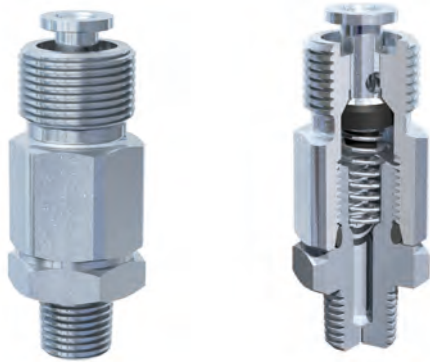
Special Test Coupling Solutions
 STAUFF Test

Pressure Test Connection for Compressed-Air Pneumatic Braking Equipment (according to ISO 3583)



Test Coupling with Female Connection Port



Gauge Adaptor with Test Coupling



Banjo Fitting with Test Coupling

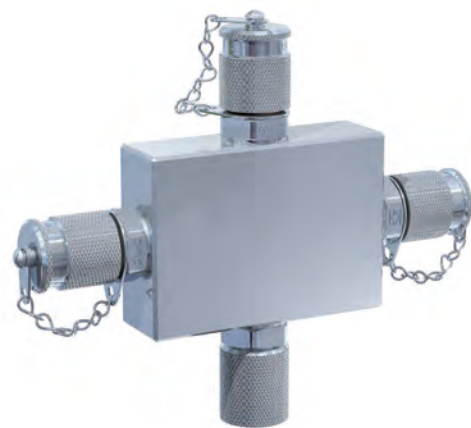

Triple Manifold Block with Test Couplings

Custom-designed test coupling solutions in addition to the Original-STAUFF-Test range according to customers specifications or based on STAUFF developments.

If you have similar requirements please consult STAUFF.

Port Connections and Sealing Details

<p>Type A</p>	<p>Type A - Threaded port according to factory standard Sealing: O-ring Type A</p>			
	Thread	Dimensions (mm/in)		
G	d1 +0,1	t1 min.	t2 min	
M8 x 1	9,5 .37	11 .43	15,5 .61	
M10 x 1	11,5 .45	12 .47	16,5 .64	

<p>Type B and C</p>	<p>Type B and C - Threaded port type X acc. to DIN 3852 Part 1 and 2; ISO 9974-1 (metric); ISO 1179-1 (inch) Sealing: Metal joint Type B / Elastomeric sealing Type C</p>				
	Thread	Dimensions (mm/in)			
G	d1 min.	t1 min.	t2 min.	a max.	
M10 x 1	15 .59	8 .31	10 .39	1 .04	
M12 x 1,5	18 .71	12 .47	15 .59	1,5 .06	
M14 x 1,5	20 .79	12 .47	15 .59	1,5 .06	
M16 x 1,5	23 .91	12 .47	15 .59	1,5 .06	
M18 x 1,5	25 .98	12 .47	15 .59	2 .08	
M20 x 1,5	27 1.06	14 .55	17 .67	2 .08	
M22 x 1,5	28 1.10	14 .55	17 .67	2,5 .10	
G1/8	15 .59	8,5 .33	10,5 .41	1 .04	
G1/4	20 .79	12,5 .49	15,5 .61	1,5 .06	
G3/8	23 .91	12,5 .49	15,5 .61	2 .08	
G1/2	28 1.10	14,5 .57	18,5 .73	2,5 .10	

<p>Type D</p>	<p>Type D - Parallel threaded port type Z according to DIN 3852 Part 2 (inch) Sealing: Taper Type D suitable sealant required</p>		
	Thread	Dimensions (mm/in)	
G	t1 min.	t2 min.	
Rp1/8	5,5 .22	9,5 .37	
Rp1/4	8,5 .33	13,5 .53	
Rp3/8	8,5 .33	13,5 .53	
Rp1/2	10,5 .41	16,5 .65	

Port Connections and Sealing Details

Type D	Type D - Taper threaded port according to ANSI/ASME B1.20.1-1983 (NPT) Sealing: Taper Type D suitable sealant required		
	Thread	Dimensions (mm/in)	
	G	t1 min.	t2 min.
	1/8-27 NPT	6,9 .27	11,6 .46
	1/4-18 NPT	10 .39	16,4 .65
	1/2-14 NPT	13,6 .54	22,6 .89

Type E	Type E - Threaded port according to ISO 6149-1 (metric); ISO 11926-1 (UNF) Sealing: O-ring Type E							
	Thread	Dimensions (mm/in)						
	G	d1 +0,1	d2 min.	t1 min.	t2 min.	a +0,4	b max.	z° ±1°
	M10 x 1	11,1 .44	16 .63	10 .39	11,5 .45	1,6 .06	1 .04	12°
	M12 x 1,5	13,8 .54	19 .75	11,5 .45	14 .55	2,4 .09	1,5 .06	15°
	M14 x 1,5	15,8 .62	21 .83	11,5 .45	14 .55	2,4 .09	1,5 .06	15°
	M16 x 1,5	17,8 .70	24 .94	13 .51	15,5 .61	2,4 .09	1,5 .06	15°
	M22 x 1,5	23,8 .94	29 1.14	15,5 .61	18 .71	2,4 .09	2 .08	15°
	M27 x 2	29,4 1.16	34 1.34	19 .75	22 .87	3,1 .91	2 .08	15°
	5/16-24 UNF	9,1 .36	17 .67	10 .39	12 .47	1,9 .07	1,6 .06	12°
	7/16-24 UNF	12,4 .49	21 .83	11,5 .45	14 .55	2,4 .09	1,6 .06	12°
	1/2-20 UNF	14 .55	23 .91	11,5 .45	14 .55	2,4 .09	1,6 .06	12°
	9/16-18 UNF	15,65 .62	25 .98	12,7 .50	15,5 .61	2,5 .10	1,6 .06	12°
	7/8-14 UNF	23,95 .94	34 1.34	16,7 .66	20 .79	2,5 .10	2,4 .09	15°

